



LOW NOISE, HIGH IP3

Monolithic Amplifier

PSA4-5043+

Mini-Circuits

50Ω 0.05 to 4 GHz

THE BIG DEAL

- Ultra Low Noise Figure, 0.75 dB typ. at 1 GHz
- High IP3, up to 33.5 dBm typ. at 1 GHz
- Class 1B ESD rating (500V)
- Output Power at 1dB comp., up to +21 dBm typ.
- Gain, 18.4 dB typ. at 1GHz
- Supply Voltage, +3V, Id=33mA, +5V, Id=56mA
- Aqueous washable
- May be used as a replacement for SPF5043Z^{a,b}



Generic photo used for illustration purposes only

CASE STYLE: MMM1362

+RoHS Compliant

The +Suffix identifies RoHS Compliance. See our web site for RoHS Compliance methodologies and qualifications

APPLICATIONS

- Cellular
- ISM
- GSM
- WCDMA
- LTE
- WiMax
- WLAN
- GPS

PRODUCT OVERVIEW

Mini-Circuits PSA4-5043+ is a E-PHEMT* based Ultra-Low Noise MMIC Amplifier operating from 50 MHz to 4 GHz with a unique combination of low noise and high IP3 making this amplifier ideal for sensitive high dynamic range receiver applications. This design operates on +3 to +5V supply at only 33 mA at 3V and 56mA at +5V, is internally matched to 50 ohms and is supplied in a super small SC-70 (SOT-343) MSL 1 package.

KEY FEATURES

Feature	Advantages
Ultra Low Noise: 0.75 dB at 1 GHz 0.98 dB at 2 GHz	Outstanding Noise Figure, measured in a 50 Ohm environment without any external matching
High IP3, 33.5 dBm	Combining Low Noise and High IP3 makes this MMIC amplifier ideal for Low Noise Receiver Front End (RFE) because it gives the user advantages at both ends of the dynamic range: sensitivity & two-tone spur-free dynamic range
High Output Power, +21 dBm	The PSA4-5043+ provides up to +21dBm output power at 1dB compression enabling this amplifier to support high linear dynamic range requirements.-
Broad Band, up to 4 GHz	Operating over a broadband from 50 MHz to 4 GHz, the PSA4-5043+ covers the primary wireless communications bands: Cellular, PCS, LTE, WiMAX
Internally Matched	No external matching elements required to achieve the advertised noise and output power over the full band
SOT-343 Package	Small size, industry standard package
High Reliability	Low, small signal operating current of 53mA nominal maintains junction temperatures typically below 125°C at 85°C ground lead temperature
Class 1B ESD (500V, HBM)	The PSA4-5043+ is a super low noise PHEMT based design. Unlike many other PHEMT designs. Mini-Circuits incorporates ESD protection on die to achieve industry leading ESD performance for a low noise amplifier.

* Enhancement mode pseudomorphic High Electron Mobility Transistor.

A. Suitability for model replacement within a particular system must be determined by and is solely the responsibility of the customer based on, among other things, electrical performance criteria, stimulus conditions, application, compatibility with other components and environmental conditions and stresses.

B. The RFMD SPF5043Z part number is used for identification and comparison purposes only.

REV. C
ECO-011279
PSA4-5043+
MCL NY
220105



ELECTRICAL SPECIFICATIONS⁽¹⁾ AT 25°C, ZO=50Ω, (REFER TO CHARACTERIZATION CIRCUIT, FIG. 1)

Parameter	Condition (GHz)	Vd=5.0V ⁽¹⁾			Vd=3.0V ⁽¹⁾			Units
		Min.	Typ.	Max.	Min.	Typ.	Max.	
Frequency Range		0.05		4.0	0.05		4.0	GHz
at DC Volts (Vd)			5.0			3.0		V
DC Current (Id)			58	66		33		mA
Noise Figure	0.05		0.73	—		0.66		dB
	0.5		0.65	—		0.66		
	1.0		0.75	1.1		0.73		
	2.0		0.98	—		0.94		
	3.0		1.1	—		1.1		
	4.0		1.44	—		1.3		
Gain	0.05	—	25.4	—		24.3		dB
	0.5	—	22.1	—		21.2		
	1.0	16.5	18.4	20.2		17.5		
	2.0	—	13.3	—		12.5		
	3.0	—	10.2	—		9.6		
	4.0	—	8.0	—		7.2		
Input Return Loss	0.05		7.8			6.5		dB
	0.5		10.5			9.4		
	1.0		11.4			10.6		
	2.0		12.2			11.1		
	3.0		12.8			10.4		
	4.0		11.1			9.2		
Output Return Loss	0.05		13.7			13.2		dB
	0.5		15.0			15.9		
	1.0		13.9			15.1		
	2.0		12.5			14.5		
	3.0		11.7			13.3		
	4.0		12.8			15.7		
Output IP3	0.05		31.0			28.0		dBm
	0.5		32.1			28.0		
	1.0		33.5			28.7		
	2.0		32.7			30.0		
	3.0		33.6			31.0		
	4.0		32.6			31.0		
Output Power @1dB compression ⁽²⁾	0.05		18.9			15.8		dBm
	0.5		19.3			16.5		
	1.0		19.8			17.4		
	2.0		20.7			19.0		
	3.0		21.2			19.4		
	4.0		21.5			19.8		
DC Current Variation Vs. Temperature ⁽³⁾			-0.007			-0.007		mA/°C
DC Current Variation Vs. Voltage			0.01			0.01		mA/mV
Thermal Resistance ⁽⁵⁾			117			117		°C/W



MAXIMUM RATINGS⁽⁴⁾

Parameter	Ratings
Operating Temperature ⁽⁵⁾	-40°C to 85°C
Storage Temperature	-65°C to 150°C
Channel Temperature	150°C
DC Voltage	6V
Device Current	76 mA
Power Dissipation	380 mW
Input Power (CW)	23 dBm (5 minutes max), 17dBm (continuous)

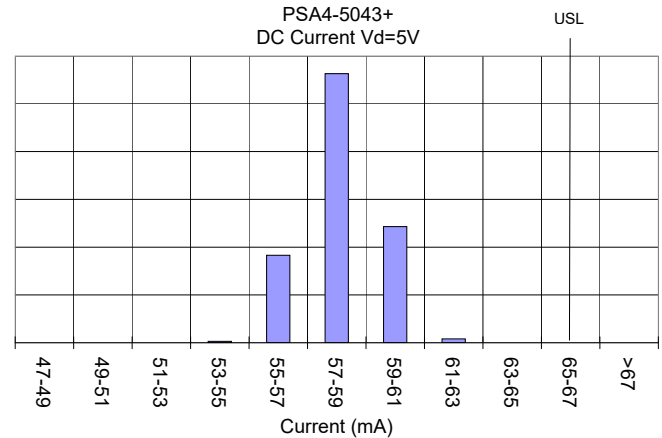

- (1) Measured on Mini-Circuits Characterization test board TB-471+. See Characterization Test Circuit (Fig. 1)
- (2) Current increases at P1dB
- (3) Current at 85°C - Current at -45°C/130
- (4) Permanent damage may occur if any of these limits are exceeded. These maximum ratings are not intended for continuous normal operation.
- (5) Defined with reference to ground pad temperature.

SIMPLIFIED SCHEMATIC AND PIN DESCRIPTION

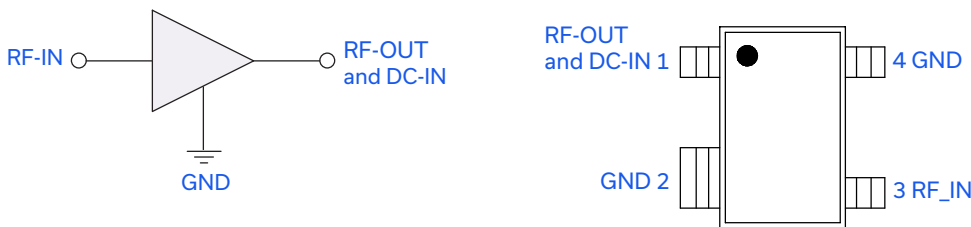

Function	Pin Number	Description (See Application Circuit, Fig. 2)
RF-IN	3	RF input pin (connect to RF-IN via DC blocking cap)
RF-OUT & DC-IN	1	RF output pin (connected to RF-out via blocking cap C2 and supply voltage Vd via RF Choke L1)
GND	2,4	Connections to ground: use via holes as shown in "Suggested Layout for PCB Design" to reduce ground path inductance for best performance.



LOW NOISE, HIGH IP3

Monolithic Amplifier

PSA4-5043+

CHARACTERIZATION TEST CIRCUIT

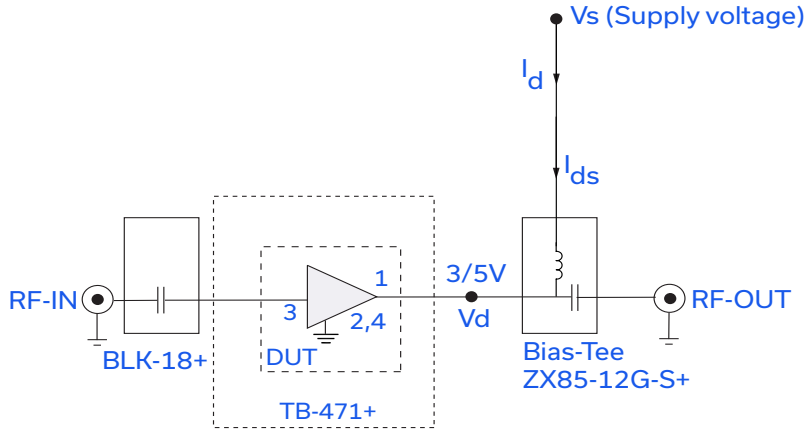

Fig 1. Block Diagram of Test Circuit used for characterization. (DUT soldered on Mini-Circuits Characterization Test Board TB-471+)
Gain, Return loss, Output power at 1dB compression (P1 dB), Output IP3 (OIP3) and Noise Figure measured using Agilent's N5242A PNA-X microwave network analyzer.

Conditions:

1. Gain: Pin= -25dBm
2. Output IP3 (OIP3): Two tones, spaced 1 MHz apart, 5 dBm/ tone at output.

RECOMMENDED APPLICATION CIRCUIT

(refer to evaluation board for PCB Layout and component values)

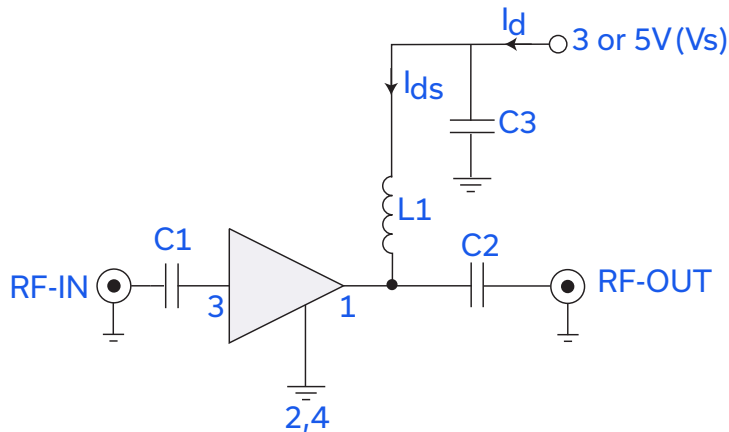
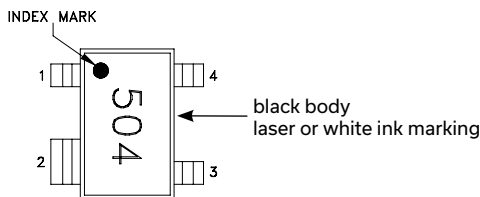

Fig 2. Recommended Application Circuit
Note: Resistance of L1, 0.1-0.2Ω typically

PRODUCT MARKING



Marking may contain other features or characters for internal lot control





LOW NOISE, HIGH IP3

Monolithic Amplifier

PSA4-5043+

ADDITIONAL DETAILED TECHNICAL INFORMATION IS AVAILABLE ON OUR DASH BOARD. TO ACCESS [CLICK HERE](#)

Performance Data	Data Table Swept Graphs S-Parameter (S2P Files) Data Set (.zip file)
Case Style	MMM1362 Plastic molded SOT-343 package, lea finishi: matte tin
Tape & Reel Standard quantities available on reel	F90 7" reels with 20, 50, 100, 200, 500,1K,2K or 3K devices
Suggested Layout for PCB Design	PL-361
Evaluation Board	TB-653+
Environmental Ratings	ENV08T2

ESD RATING

Human Body Model (HBM): Class 1B (500 to <1000V) in accordance with ANSI/ESD STM 5.1 - 2001

Machine Model (MM): Class M1 (pass 35V) in accordance with ANSI/ESD STM5.2-1999; passes 35V

MSL RATING

Moisture Sensitivity: MSL1 in accordance with IPC/JEDEC J-STD-020D

MSL TEST FLOW CHART

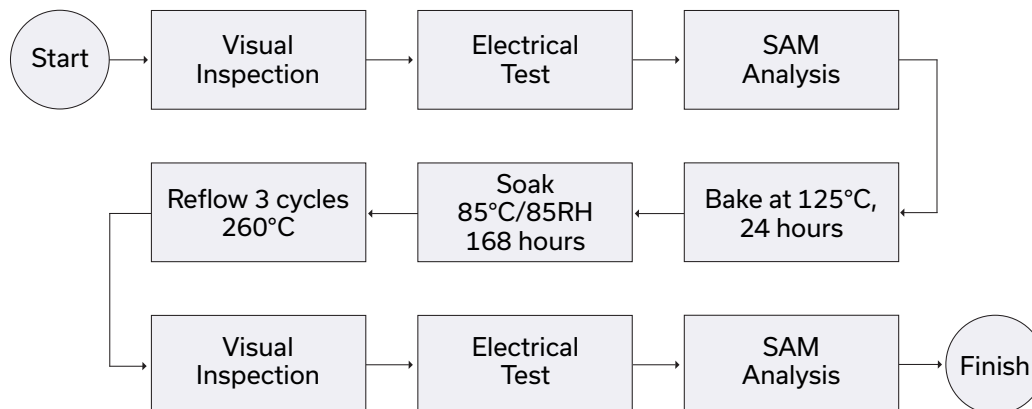

- NOTES**
- A. Performance and quality attributes and conditions not expressly stated in this specification document are intended to be excluded and do not form a part of this specification document.
 - B. Electrical specifications and performance data contained in this specification document are based on Mini-Circuit's applicable established test performance criteria and measurement instructions.
 - C. The parts covered by this specification document are subject to Mini-Circuits standard limited warranty and terms and conditions (collectively, "Standard Terms"); Purchasers of this part are entitled to the rights and benefits contained therein. For a full statement of the standard. Terms and the exclusive rights and remedies thereunder, please visit Mini-Circuits' website at www.minicircuits.com/MCLStore/terms.jsp



Typical Performance Data

NOTE: Use PDF Bookmarks to view DATA at required conditions

Definitions:

Input Return Loss = -S11 (dB)

Gain(Power Gain) = S21 (dB)

Reverse Isolation = -S12 (dB)

Output Return Loss = -S22 (dB)

TEST CONDITIONS: RF Input Power = -25dBm, Vd = 5.00V, Id = 58.6mA @ Temperature = 25degC

FREQ	Gain	Isolation	Input Return Loss	Output Return Loss	Stability		IP-3 Output	1dB Comp. Output	Noise Figure
					K	Measure			
(MHz)	(dB)	(dB)	(dB)	(dB)	K	Measure	(dBm)	(dBm)	(dB)
50	25.55	29.50	8.40	15.44	0.97	0.71	32.94	19.82	0.64
60	25.36	29.61	8.79	16.44	1.00	0.73	33.24	20.01	0.64
70	25.26	29.10	9.28	17.63	1.00	0.68	33.07	20.01	0.58
80	25.17	28.94	9.57	18.66	1.01	0.67	32.74	19.80	0.62
90	25.09	28.92	9.81	19.42	1.02	0.66	32.71	19.77	0.64
100	25.04	28.85	9.97	20.01	1.03	0.66	32.64	19.63	0.61
150	24.77	28.63	10.53	21.37	1.04	0.65	32.64	19.96	0.56
200	24.47	28.65	10.80	20.85	1.07	0.67	32.85	19.64	0.59
250	24.14	28.62	11.03	20.03	1.09	0.68	32.83	19.85	0.53
300	23.78	28.40	11.27	19.05	1.10	0.69	33.04	19.75	0.66
350	23.39	28.21	11.48	18.34	1.11	0.70	33.04	19.94	0.64
400	23.00	28.00	11.63	17.66	1.12	0.71	33.22	19.61	0.64
450	22.59	27.78	11.85	17.13	1.13	0.72	33.65	19.94	0.65
500	22.17	27.55	12.02	16.72	1.14	0.73	33.45	20.11	0.65
550	21.75	27.20	12.19	16.34	1.14	0.73	33.87	19.91	0.60
650	20.94	26.66	12.51	15.75	1.16	0.75	33.94	20.16	0.64
700	20.54	26.30	12.60	15.51	1.16	0.75	34.24	20.24	0.62
750	20.14	25.96	12.75	15.36	1.16	0.76	34.04	20.37	0.78
800	19.77	25.66	12.87	15.18	1.16	0.76	34.26	20.58	0.70
850	19.39	25.37	12.98	15.00	1.16	0.77	34.60	20.62	0.65
900	19.03	25.02	13.08	14.84	1.16	0.77	34.76	20.75	0.67
950	18.68	24.68	13.18	14.68	1.16	0.77	34.72	21.05	0.71
1000	18.34	24.43	13.25	14.55	1.16	0.78	34.42	21.09	0.68
1200	17.08	23.23	13.51	14.16	1.16	0.78	35.00	21.25	0.79
1400	15.96	22.21	13.75	13.88	1.16	0.79	34.93	21.24	0.80
1600	14.95	21.21	13.96	13.54	1.15	0.79	35.26	21.71	0.84
1800	14.07	20.31	14.15	13.38	1.15	0.79	35.58	21.36	0.89
2000	13.26	19.47	14.39	13.09	1.14	0.78	35.94	22.09	0.93
2200	12.51	18.76	14.49	12.95	1.14	0.78	35.80	21.75	0.90
2400	11.85	18.06	14.55	12.86	1.14	0.78	35.95	22.05	0.89
2600	11.23	17.45	14.59	12.80	1.14	0.78	36.06	22.05	1.05
2800	10.67	16.82	14.47	12.86	1.13	0.78	35.64	21.94	1.09
3000	10.15	16.25	14.35	12.81	1.13	0.78	35.61	21.53	1.03
3200	9.67	15.74	14.01	13.01	1.12	0.78	35.74	21.99	1.25
3400	9.22	15.23	13.59	13.14	1.11	0.79	35.08	22.07	1.30
3600	8.78	14.77	13.11	13.38	1.11	0.79	35.07	22.07	1.30
3800	8.37	14.34	12.56	13.62	1.11	0.80	34.61	22.02	1.35
4000	7.97	13.94	12.02	13.79	1.10	0.81	35.40	22.79	1.47

Typical Performance Data

Definitions:

Input Return Loss = -S11 (dB)

Gain(Power Gain) = S21 (dB)

Reverse Isolation = -S12 (dB)

Output Return Loss = -S22 (dB)

TEST CONDITIONS: RF Input Power = -25dBm, Vd = 4.75V, Id = 55.66mA @ Temperature = 25degC

FREQ	Gain	Isolation	Input Return Loss	Output Return Loss	Stability		IP-3 Output	1dB Comp. Output	Noise Figure
					K	Measure			
(MHz)	(dB)	(dB)	(dB)	(dB)	K	Measure	(dBm)	(dBm)	(dB)
50	25.46	28.31	8.37	15.30	0.93	0.60	32.67	20.05	0.62
60	25.27	28.99	8.70	16.26	0.98	0.67	33.00	20.01	0.62
70	25.17	29.06	9.11	17.32	1.00	0.68	32.85	19.99	0.57
80	25.08	28.98	9.40	18.24	1.01	0.68	32.54	19.75	0.63
90	25.01	28.87	9.64	18.95	1.02	0.67	32.50	19.76	0.62
100	24.95	28.94	9.80	19.53	1.03	0.67	32.40	19.63	0.62
150	24.69	28.87	10.36	20.79	1.06	0.68	32.31	19.91	0.53
200	24.40	28.62	10.60	20.32	1.07	0.67	32.54	19.73	0.59
250	24.07	28.43	10.83	19.60	1.08	0.67	32.69	19.79	0.53
300	23.72	28.36	11.08	18.79	1.10	0.69	32.71	19.74	0.60
350	23.33	28.16	11.27	18.18	1.11	0.70	32.65	19.95	0.62
400	22.94	27.97	11.45	17.56	1.12	0.71	32.84	19.62	0.65
450	22.53	27.77	11.66	17.01	1.13	0.72	33.28	19.98	0.64
500	22.12	27.44	11.83	16.63	1.13	0.73	33.08	20.12	0.64
550	21.70	27.17	11.98	16.26	1.14	0.74	33.50	20.00	0.63
650	20.89	26.52	12.33	15.72	1.15	0.75	33.68	20.16	0.64
700	20.49	26.21	12.43	15.52	1.15	0.75	33.88	20.34	0.62
750	20.10	25.88	12.60	15.43	1.15	0.76	33.68	20.42	0.74
800	19.72	25.64	12.73	15.24	1.16	0.77	33.84	20.66	0.68
850	19.35	25.27	12.82	15.05	1.16	0.77	34.18	20.68	0.67
900	18.99	24.99	12.92	14.85	1.16	0.77	34.36	20.85	0.68
950	18.64	24.70	13.02	14.65	1.16	0.78	34.43	21.11	0.68
1000	18.31	24.31	13.08	14.50	1.15	0.77	33.85	21.17	0.70
1200	17.04	23.20	13.39	14.23	1.16	0.78	34.46	21.36	0.82
1400	15.93	22.13	13.61	13.86	1.15	0.79	34.48	21.40	0.84
1600	14.93	21.16	13.86	13.61	1.15	0.79	34.82	21.75	0.84
1800	14.04	20.26	14.02	13.36	1.15	0.79	34.85	21.45	0.90
2000	13.24	19.43	14.27	13.18	1.14	0.78	35.40	22.13	0.92
2200	12.50	18.71	14.37	12.98	1.14	0.78	35.02	21.81	0.92
2400	11.83	18.01	14.44	12.89	1.14	0.78	35.14	22.13	0.91
2600	11.22	17.39	14.47	12.88	1.13	0.78	35.43	22.12	1.05
2800	10.66	16.78	14.29	12.92	1.13	0.78	34.79	21.98	1.12
3000	10.13	16.23	14.31	12.90	1.13	0.78	34.42	21.69	1.06
3200	9.66	15.68	13.87	12.99	1.12	0.78	34.52	22.03	1.16
3400	9.20	15.20	13.49	13.34	1.11	0.79	33.63	22.03	1.27
3600	8.77	14.73	13.00	13.43	1.11	0.79	33.46	22.09	1.18
3800	8.36	14.30	12.49	13.76	1.10	0.80	32.95	22.04	1.28
4000	8.0	13.9	11.90	13.85	1.10	0.81	33.89	22.74	1.62

Typical Performance Data

Definitions:

Input Return Loss = -S11 (dB)

Gain(Power Gain) = S21 (dB)

Reverse Isolation = -S12 (dB)

Output Return Loss = -S22 (dB)

TEST CONDITIONS: RF Input Power = -25dBm, Vd = 5.25V, Id = 61.32mA @ Temperature = 25degC

FREQ	Gain	Isolation	Input Return Loss	Output Return Loss	Stability		IP-3 Output	1dB Comp. Output	Noise Figure
					K	Measure			
(MHz)	(dB)	(dB)	(dB)	(dB)	K	Measure	(dBm)	(dBm)	(dB)
50	25.62	29.29	8.19	15.31	0.95	0.70	33.04	19.79	0.65
60	25.43	28.76	8.79	16.48	0.97	0.63	33.32	19.87	0.65
70	25.33	29.13	9.16	17.43	1.00	0.67	33.09	19.90	0.60
80	25.24	29.09	9.44	18.36	1.01	0.67	32.73	19.67	0.64
90	25.17	29.10	9.69	19.09	1.02	0.67	32.68	19.65	0.65
100	25.11	29.02	9.82	19.59	1.03	0.67	32.64	19.47	0.65
150	24.85	28.85	10.38	20.69	1.05	0.66	32.62	19.80	0.56
200	24.55	28.79	10.64	20.13	1.07	0.67	32.78	19.54	0.58
250	24.21	28.61	10.88	19.35	1.08	0.68	32.77	19.69	0.54
300	23.85	28.54	11.12	18.49	1.10	0.69	33.04	19.65	0.61
350	23.45	28.26	11.33	17.78	1.11	0.69	33.07	19.77	0.62
400	23.05	28.13	11.51	17.15	1.12	0.71	33.25	19.61	0.67
450	22.64	27.90	11.72	16.64	1.13	0.72	33.61	19.76	0.68
500	22.22	27.67	11.90	16.23	1.14	0.73	33.23	19.86	0.68
550	21.80	27.42	12.06	15.88	1.15	0.74	33.63	19.73	0.59
650	20.97	26.78	12.41	15.30	1.16	0.75	33.87	19.93	0.65
700	20.57	26.43	12.52	15.13	1.16	0.76	34.17	20.06	0.64
750	20.18	26.08	12.68	15.00	1.16	0.76	34.19	20.18	0.69
800	19.80	25.76	12.80	14.84	1.16	0.76	34.19	20.37	0.68
850	19.42	25.45	12.93	14.63	1.16	0.77	34.58	20.35	0.69
900	19.06	25.10	13.02	14.42	1.16	0.77	34.73	20.53	0.70
950	18.70	24.80	13.10	14.25	1.16	0.77	34.73	20.80	0.69
1000	18.36	24.54	13.18	14.11	1.16	0.78	34.13	20.86	0.71
1200	17.09	23.37	13.49	13.82	1.17	0.79	35.08	20.94	0.82
1400	15.97	22.26	13.72	13.46	1.16	0.79	34.93	20.95	0.84
1600	14.97	21.30	13.97	13.24	1.16	0.79	35.17	21.42	0.83
1800	14.08	20.41	14.13	12.97	1.15	0.79	35.65	21.12	0.93
2000	13.28	19.59	14.38	12.77	1.15	0.79	36.21	21.84	0.91
2200	12.53	18.83	14.47	12.59	1.14	0.78	35.88	21.46	0.92
2400	11.86	18.15	14.54	12.53	1.14	0.78	36.21	21.83	0.90
2600	11.25	17.52	14.58	12.49	1.14	0.78	36.36	21.92	1.04
2800	10.68	16.90	14.41	12.51	1.13	0.78	35.62	21.64	1.17
3000	10.16	16.36	14.42	12.49	1.13	0.78	35.78	21.41	1.05
3200	9.68	15.80	13.97	12.61	1.12	0.78	35.81	21.83	1.16
3400	9.22	15.31	13.61	12.89	1.12	0.79	35.21	21.92	1.30
3600	8.79	14.85	13.09	12.93	1.11	0.80	35.32	21.88	1.30
3800	8.38	14.43	12.61	13.29	1.11	0.80	35.05	21.80	1.29
4000	7.97	14.01	12.01	13.35	1.10	0.81	35.79	22.67	1.57

Typical Performance Data

Definitions:

Input Return Loss = -S11 (dB)

Gain(Power Gain) = S21 (dB)

Reverse Isolation = -S12 (dB)

Output Return Loss = -S22 (dB)

TEST CONDITIONS: RF Input Power = -25dBm, Vd = 5.00V, Id = 60.19mA @ Temperature = -45degC

FREQ	Gain	Isolation	Input Return Loss	Output Return Loss	Stability		IP-3 Output	1dB Comp. Output	Noise Figure
					K	Measure			
(MHz)	(dB)	(dB)	(dB)	(dB)	K	Measure	(dBm)	(dBm)	(dB)
50	25.40	28.48	9.24	15.36	0.91	0.66	33.39	20.52	0.54
60	25.14	31.48	9.65	16.47	1.10	0.89	34.00	20.64	0.54
70	24.99	28.28	10.94	18.79	0.98	0.63	33.94	20.73	0.47
80	24.86	28.12	11.49	20.70	1.00	0.61	33.59	20.34	0.51
90	24.77	28.16	11.90	22.38	1.01	0.62	33.74	20.41	0.52
100	24.69	28.10	12.20	24.23	1.02	0.62	33.85	20.30	0.49
150	24.41	27.88	13.32	38.26	1.04	0.60	33.87	20.83	0.45
200	24.13	27.85	13.54	33.27	1.06	0.61	33.97	20.31	0.49
250	23.83	27.75	13.96	26.93	1.08	0.62	34.18	20.50	0.43
300	23.52	27.63	14.13	23.79	1.09	0.63	34.34	20.43	0.50
350	23.17	27.52	14.36	22.10	1.11	0.64	34.26	20.59	0.51
400	22.82	27.28	14.46	20.99	1.11	0.65	34.48	20.01	0.55
450	22.45	27.15	14.51	19.85	1.13	0.67	34.93	20.71	0.54
500	22.07	26.91	14.60	19.00	1.14	0.67	34.69	20.93	0.49
550	21.68	26.60	14.45	18.29	1.14	0.68	35.41	20.68	0.42
650	20.93	26.20	14.56	17.24	1.15	0.70	35.43	21.05	0.52
700	20.55	25.83	14.74	16.90	1.15	0.70	35.59	21.18	0.46
750	20.19	25.55	14.79	16.70	1.16	0.71	35.51	21.22	0.54
800	19.83	25.29	14.87	16.56	1.16	0.72	35.58	21.73	0.53
850	19.48	25.01	14.95	16.36	1.16	0.72	35.97	21.70	0.54
900	19.14	24.68	14.83	16.10	1.16	0.73	36.23	21.95	0.52
950	18.80	24.41	14.92	15.82	1.16	0.73	36.24	22.27	0.52
1000	18.48	24.12	14.70	15.65	1.16	0.74	35.77	22.29	0.53
1200	17.26	22.98	14.91	15.22	1.15	0.75	36.59	22.48	0.64
1400	16.17	21.93	14.90	14.80	1.15	0.75	36.82	22.52	0.63
1600	15.19	20.99	14.95	14.51	1.14	0.76	36.91	22.84	0.62
1800	14.32	20.10	14.88	14.21	1.13	0.76	37.38	22.62	0.72
2000	13.54	19.28	15.21	13.88	1.13	0.75	38.05	23.15	0.71
2200	12.80	18.55	15.16	13.56	1.12	0.75	37.59	22.97	0.69
2400	12.15	17.85	15.25	13.41	1.12	0.75	38.02	23.16	0.65
2600	11.54	17.23	15.24	13.28	1.11	0.75	38.19	23.19	0.78
2800	10.99	16.59	15.35	13.14	1.11	0.74	37.49	23.09	0.91
3000	10.45	16.06	15.20	13.12	1.10	0.75	38.15	22.75	0.78
3200	10.00	15.51	14.62	13.13	1.09	0.75	37.97	22.92	0.95
3400	9.54	15.03	14.24	13.55	1.09	0.75	37.70	22.98	1.02
3600	9.14	14.58	13.89	13.41	1.08	0.75	37.68	23.04	0.91
3800	8.74	14.13	13.21	13.91	1.08	0.76	37.17	22.95	0.96
4000	8.33	13.74	12.30	14.24	1.07	0.78	38.03	23.66	1.02

Typical Performance Data

Definitions:

Input Return Loss = -S11 (dB)

Gain(Power Gain) = S21 (dB)

Reverse Isolation = -S12 (dB)

Output Return Loss = -S22 (dB)

TEST CONDITIONS: RF Input Power = -25dBm, Vd = 4.75V, Id = 57.2mA @ Temperature = -45degC

FREQ	Gain	Isolation	Input Return Loss	Output Return Loss	Stability		IP-3 Output	1dB Comp. Output	Noise Figure
					K	Measure			
(MHz)	(dB)	(dB)	(dB)	(dB)			(dBm)	(dBm)	(dB)
50	25.45	28.57	9.48	15.63	0.93	0.64	33.28	20.08	0.49
60	25.19	28.79	10.26	17.23	0.97	0.68	33.79	20.28	0.49
70	25.05	28.39	10.97	18.89	0.98	0.64	33.75	20.41	0.44
80	24.92	28.35	11.53	20.61	1.00	0.63	33.59	19.93	0.48
90	24.83	28.33	11.99	22.26	1.02	0.63	33.65	20.07	0.49
100	24.76	28.18	12.31	24.10	1.02	0.62	33.70	19.96	0.49
150	24.47	28.01	13.32	38.59	1.05	0.61	33.59	20.65	0.43
200	24.19	28.00	13.75	33.70	1.07	0.62	33.99	19.95	0.47
250	23.89	27.81	14.03	27.13	1.08	0.62	33.99	20.12	0.43
300	23.58	27.80	14.26	23.90	1.10	0.64	34.19	20.04	0.44
350	23.23	27.69	14.45	22.18	1.11	0.65	34.09	20.26	0.47
400	22.87	27.49	14.50	20.86	1.12	0.66	34.28	19.80	0.51
450	22.50	27.26	14.61	19.89	1.13	0.67	34.76	20.53	0.50
500	22.12	27.03	14.64	19.15	1.14	0.68	34.58	20.79	0.50
550	21.74	26.84	14.66	18.47	1.15	0.69	35.17	20.51	0.47
650	20.98	26.22	14.76	17.36	1.15	0.70	35.20	20.86	0.50
700	20.61	25.97	14.78	16.98	1.16	0.71	35.45	20.97	0.47
750	20.23	25.67	14.87	16.77	1.16	0.72	35.22	21.16	0.53
800	19.88	25.35	14.93	16.58	1.16	0.72	35.40	21.51	0.54
850	19.53	25.01	14.98	16.38	1.16	0.72	35.79	21.53	0.52
900	19.18	24.74	14.98	16.18	1.16	0.73	36.08	21.77	0.50
950	18.85	24.45	14.96	15.95	1.16	0.73	36.02	22.02	0.54
1000	18.53	24.14	14.92	15.75	1.16	0.73	35.50	22.07	0.53
1200	17.30	23.03	14.95	15.25	1.16	0.75	36.17	22.28	0.62
1400	16.22	21.99	14.96	14.86	1.15	0.75	36.33	22.34	0.63
1600	15.24	20.99	15.00	14.59	1.14	0.75	36.53	22.67	0.64
1800	14.37	20.15	15.01	14.21	1.14	0.76	36.82	22.48	0.68
2000	13.58	19.30	15.17	14.00	1.13	0.75	37.29	22.93	0.67
2200	12.84	18.58	15.28	13.64	1.12	0.75	37.16	22.78	0.69
2400	12.19	17.87	15.33	13.55	1.12	0.75	37.45	22.97	0.63
2600	11.58	17.24	15.35	13.30	1.11	0.75	37.63	23.00	0.73
2800	11.03	16.63	15.26	13.29	1.11	0.74	36.88	22.87	0.81
3000	10.49	16.10	15.33	13.24	1.11	0.74	36.95	22.56	0.74
3200	10.05	15.52	14.77	13.27	1.09	0.74	37.19	22.84	0.82
3400	9.59	15.06	14.35	13.54	1.09	0.75	36.19	22.80	0.98
3600	9.19	14.58	13.93	13.54	1.08	0.75	36.13	22.88	0.85
3800	8.78	14.12	13.22	14.15	1.08	0.76	35.76	22.80	0.98
4000	8.39	13.74	12.40	14.32	1.07	0.77	36.86	23.46	1.05

Typical Performance Data

Definitions:

Input Return Loss = -S11 (dB)

Gain(Power Gain) = S21 (dB)

Reverse Isolation = -S12 (dB)

Output Return Loss = -S22 (dB)

TEST CONDITIONS: RF Input Power = -25dBm, Vd = 5.25V, Id = 64.46mA @ Temperature = -45degC

FREQ	Gain	Isolation	Input Return Loss	Output Return Loss	Stability		IP-3 Output	1dB Comp. Output	Noise Figure
					K	Measure			
(MHz)	(dB)	(dB)	(dB)	(dB)	K	Measure	(dBm)	(dBm)	(dB)
50	25.60	28.59	9.55	15.62	0.92	0.64	33.74	20.60	0.53
60	25.35	28.99	10.32	17.39	0.97	0.68	34.12	20.94	0.53
70	25.20	28.52	11.11	19.10	0.98	0.63	34.18	20.95	0.46
80	25.08	28.43	11.69	20.92	1.00	0.62	33.93	20.64	0.51
90	24.99	28.38	12.14	22.68	1.01	0.62	34.02	20.69	0.54
100	24.92	28.38	12.47	24.42	1.02	0.62	33.95	20.52	0.50
150	24.62	28.37	13.51	39.07	1.06	0.63	34.09	20.97	0.43
200	24.34	28.21	13.94	32.43	1.07	0.62	34.29	20.53	0.49
250	24.03	27.99	14.23	26.51	1.08	0.62	34.42	20.82	0.42
300	23.71	27.94	14.45	23.37	1.10	0.64	34.74	20.66	0.50
350	23.35	27.81	14.59	21.70	1.12	0.65	34.69	20.93	0.47
400	22.99	27.60	14.67	20.48	1.12	0.66	34.80	20.35	0.54
450	22.61	27.37	14.76	19.52	1.13	0.67	35.37	20.88	0.51
500	22.23	27.12	14.79	18.79	1.14	0.68	35.13	21.10	0.52
550	21.84	26.93	14.81	18.17	1.15	0.69	35.64	20.86	0.44
650	21.07	26.36	14.91	17.11	1.16	0.70	35.99	21.08	0.48
700	20.69	26.02	14.94	16.76	1.16	0.71	36.15	21.23	0.46
750	20.31	25.78	15.05	16.50	1.16	0.72	35.89	21.38	0.53
800	19.95	25.44	15.08	16.30	1.16	0.72	36.01	21.65	0.58
850	19.60	25.14	15.13	16.14	1.16	0.72	36.66	21.62	0.52
900	19.25	24.82	15.13	15.94	1.16	0.73	36.64	21.96	0.51
950	18.91	24.53	15.12	15.72	1.16	0.73	36.83	22.28	0.54
1000	18.58	24.31	15.06	15.52	1.16	0.74	36.38	22.35	0.56
1200	17.35	23.13	15.09	15.04	1.16	0.75	37.04	22.51	0.63
1400	16.26	22.06	15.11	14.66	1.15	0.75	37.12	22.54	0.63
1600	15.28	21.07	15.15	14.37	1.14	0.75	37.40	22.99	0.67
1800	14.41	20.18	15.17	14.03	1.13	0.75	37.75	22.64	0.67
2000	13.61	19.38	15.29	13.78	1.13	0.75	38.42	23.26	0.68
2200	12.88	18.62	15.40	13.44	1.12	0.75	38.43	23.03	0.68
2400	12.22	17.94	15.44	13.35	1.12	0.75	38.94	23.30	0.68
2600	11.61	17.27	15.52	13.08	1.11	0.74	38.80	23.31	0.75
2800	11.06	16.70	15.42	13.11	1.11	0.74	37.93	23.13	0.88
3000	10.52	16.16	15.45	12.98	1.11	0.74	38.71	22.76	0.76
3200	10.07	15.58	14.92	13.07	1.09	0.74	38.83	22.94	0.91
3400	9.61	15.10	14.48	13.29	1.09	0.75	38.74	23.09	0.94
3600	9.20	14.62	14.04	13.30	1.08	0.75	38.67	23.09	0.93
3800	8.79	14.18	13.33	13.84	1.08	0.76	38.42	22.99	0.93
4000	8.40	13.78	12.52	14.05	1.07	0.77	38.89	23.78	1.09

Typical Performance Data

Definitions:

Input Return Loss = -S11 (dB)

Gain(Power Gain) = S21 (dB)

Reverse Isolation = -S12 (dB)

Output Return Loss = -S22 (dB)

TEST CONDITIONS: RF Input Power = -25dBm, Vd = 5.00V, Id = 57.4mA @ Temperature = 85degC

FREQ	Gain	Isolation	Input Return Loss	Output Return Loss	Stability		IP-3 Output	1dB Comp. Output	Noise Figure
					K	Measure			
(MHz)	(dB)	(dB)	(dB)	(dB)	K	Measure	(dBm)	(dBm)	(dB)
50	25.39	29.37	7.25	13.54	0.97	0.68	31.89	18.36	0.79
60	25.22	29.95	7.55	13.92	1.01	0.74	31.94	18.24	0.79
70	25.15	29.48	7.81	14.53	1.01	0.71	31.61	18.33	0.74
80	25.07	29.45	7.99	14.94	1.02	0.70	31.32	18.12	0.75
90	25.01	29.39	8.15	15.28	1.02	0.70	31.24	18.12	0.76
100	24.96	29.37	8.25	15.46	1.03	0.70	31.14	17.98	0.75
150	24.72	29.36	8.67	15.99	1.06	0.71	31.14	18.38	0.65
200	24.42	29.11	8.97	16.01	1.06	0.71	31.32	18.08	0.68
250	24.07	28.83	9.21	15.83	1.07	0.71	31.39	18.22	0.63
300	23.70	28.74	9.44	15.50	1.09	0.73	31.69	18.14	0.65
350	23.29	28.41	9.67	15.19	1.09	0.73	31.60	18.27	0.70
400	22.87	28.25	9.84	14.85	1.11	0.74	31.74	18.12	0.77
450	22.44	28.02	10.07	14.56	1.12	0.75	32.00	18.43	0.74
500	22.02	27.70	10.29	14.36	1.12	0.76	31.75	18.51	0.75
550	21.59	27.37	10.53	14.23	1.13	0.77	32.09	18.32	0.69
650	20.76	26.79	10.99	14.07	1.14	0.78	32.30	18.57	0.75
700	20.34	26.46	11.16	13.98	1.15	0.79	32.55	18.67	0.75
750	19.93	26.13	11.37	13.89	1.15	0.79	32.50	18.83	0.79
800	19.55	25.80	11.51	13.79	1.15	0.79	32.55	18.97	0.83
850	19.17	25.46	11.64	13.61	1.15	0.80	32.88	18.95	0.81
900	18.80	25.21	11.75	13.41	1.16	0.80	33.18	19.10	0.79
950	18.44	24.89	11.90	13.25	1.16	0.80	33.01	19.32	0.83
1000	18.10	24.54	11.99	13.14	1.15	0.80	32.44	19.52	0.83
1200	16.82	23.37	12.49	13.04	1.16	0.81	33.26	19.57	0.97
1400	15.69	22.34	12.82	12.70	1.16	0.81	33.15	19.54	0.98
1600	14.69	21.35	13.16	12.62	1.16	0.81	33.49	19.91	0.98
1800	13.80	20.45	13.45	12.41	1.16	0.81	33.78	19.58	1.12
2000	12.99	19.66	13.77	12.34	1.16	0.81	34.35	20.34	1.09
2200	12.24	18.95	13.91	12.28	1.16	0.81	33.97	19.83	1.09
2400	11.57	18.22	13.93	12.30	1.16	0.81	34.47	20.27	1.12
2600	10.95	17.57	13.91	12.41	1.15	0.81	34.21	20.31	1.31
2800	10.38	17.01	13.67	12.57	1.15	0.81	33.79	20.11	1.39
3000	9.86	16.43	13.53	12.76	1.15	0.81	33.31	19.88	1.29
3200	9.37	15.90	13.09	12.88	1.14	0.82	33.43	20.24	1.49
3400	8.89	15.43	12.75	13.15	1.14	0.83	32.56	20.67	1.59
3600	8.45	14.99	12.26	13.14	1.14	0.83	32.59	20.50	1.56
3800	8.02	14.56	11.93	13.35	1.13	0.84	32.29	20.45	1.61
4000	7.61	14.17	11.39	13.19	1.13	0.85	33.18	21.25	1.84

Typical Performance Data

Definitions:

Input Return Loss = -S11 (dB)

Gain(Power Gain) = S21 (dB)

Reverse Isolation = -S12 (dB)

Output Return Loss = -S22 (dB)

TEST CONDITIONS: RF Input Power = -25dBm, Vd = 4.75V, Id = 54.51mA @ Temperature = 85degC

FREQ	Gain	Isolation	Input Return Loss	Output Return Loss	Stability		IP-3 Output	1dB Comp. Output	Noise Figure
					K	Measure			
(MHz)	(dB)	(dB)	(dB)	(dB)	K	Measure	(dBm)	(dBm)	(dB)
50	25.35	30.10	7.27	13.70	1.00	0.76	32.04	18.50	0.73
60	25.18	29.02	7.69	14.32	0.98	0.67	32.25	18.53	0.73
70	25.10	29.23	7.93	14.87	1.00	0.69	31.91	18.52	0.68
80	25.02	29.34	8.12	15.35	1.02	0.71	31.59	18.32	0.70
90	24.96	29.23	8.29	15.68	1.02	0.70	31.56	18.33	0.71
100	24.91	29.26	8.39	15.91	1.03	0.70	31.42	18.20	0.70
150	24.66	29.25	8.85	16.53	1.06	0.71	31.39	18.43	0.60
200	24.37	28.92	9.08	16.42	1.06	0.70	31.49	18.32	0.64
250	24.02	28.68	9.32	16.23	1.07	0.70	31.59	18.42	0.60
300	23.65	28.60	9.55	15.90	1.09	0.72	31.88	18.38	0.63
350	23.25	28.40	9.79	15.61	1.10	0.73	31.78	18.55	0.67
400	22.84	28.18	9.99	15.30	1.11	0.74	31.85	18.29	0.74
450	22.42	27.92	10.23	15.02	1.12	0.75	32.23	18.57	0.75
500	22.00	27.56	10.44	14.83	1.12	0.75	31.99	18.76	0.72
550	21.57	27.27	10.64	14.65	1.13	0.76	32.40	18.52	0.69
650	20.75	26.63	11.09	14.44	1.14	0.77	32.70	18.74	0.70
700	20.34	26.27	11.26	14.40	1.14	0.78	32.75	18.90	0.70
750	19.93	26.01	11.48	14.30	1.15	0.79	32.66	18.98	0.82
800	19.55	25.62	11.61	14.23	1.14	0.79	32.82	19.23	0.80
850	19.17	25.33	11.75	14.01	1.15	0.79	33.24	19.20	0.77
900	18.80	25.05	11.85	13.79	1.15	0.80	33.38	19.38	0.77
950	18.44	24.76	11.98	13.59	1.15	0.80	33.31	19.57	0.81
1000	18.11	24.44	12.06	13.50	1.15	0.80	32.76	19.64	0.78
1200	16.84	23.26	12.56	13.47	1.16	0.80	33.51	19.81	0.91
1400	15.70	22.20	12.85	13.05	1.16	0.81	33.45	19.74	0.93
1600	14.71	21.24	13.18	13.07	1.16	0.81	33.65	20.16	0.97
1800	13.81	20.35	13.42	12.76	1.15	0.81	34.01	19.85	1.04
2000	13.02	19.53	13.77	12.72	1.15	0.80	34.35	20.65	1.07
2200	12.25	18.83	13.86	12.60	1.16	0.81	33.95	20.20	1.05
2400	11.60	18.12	13.91	12.62	1.15	0.80	34.25	20.61	1.07
2600	10.98	17.48	13.90	12.68	1.15	0.80	34.36	20.70	1.22
2800	10.41	16.89	13.69	12.79	1.15	0.81	33.68	20.36	1.29
3000	9.89	16.33	13.61	12.96	1.14	0.81	33.33	20.21	1.26
3200	9.40	15.80	13.18	13.12	1.14	0.81	33.49	20.60	1.46
3400	8.92	15.32	12.86	13.31	1.14	0.82	32.53	20.97	1.51
3600	8.49	14.88	12.36	13.44	1.13	0.83	32.54	20.84	1.47
3800	8.07	14.45	12.02	13.51	1.13	0.83	32.03	20.87	1.59
4000	7.66	14.05	11.51	13.57	1.12	0.84	32.84	21.58	1.74

Typical Performance Data

Definitions:

Input Return Loss = -S11 (dB)

Gain(Power Gain) = S21 (dB)

Reverse Isolation = -S12 (dB)

Output Return Loss = -S22 (dB)

TEST CONDITIONS: RF Input Power = -25dBm, Vd = 5.25V, Id = 59.82mA @ Temperature = 85degC

FREQ	Gain	Isolation	Input Return Loss	Output Return Loss	Stability		IP-3 Output	1dB Comp. Output	Noise Figure
					K	Measure			
(MHz)	(dB)	(dB)	(dB)	(dB)	K	Measure	(dBm)	(dBm)	(dB)
50	25.50	29.09	7.50	14.04	0.94	0.67	31.46	18.27	0.75
60	25.33	30.02	7.74	14.51	1.01	0.75	31.45	18.24	0.75
70	25.25	29.43	8.08	15.16	1.01	0.70	31.18	18.18	0.69
80	25.17	29.41	8.28	15.64	1.02	0.70	30.99	18.02	0.74
90	25.11	29.34	8.44	16.01	1.02	0.69	30.91	17.97	0.73
100	25.06	29.36	8.55	16.23	1.03	0.70	30.70	17.80	0.71
150	24.81	29.35	9.00	16.81	1.06	0.71	30.77	18.07	0.62
200	24.50	29.11	9.25	16.61	1.07	0.70	30.87	17.92	0.69
250	24.16	28.87	9.49	16.32	1.08	0.70	30.99	18.07	0.63
300	23.78	28.72	9.73	15.92	1.09	0.72	31.24	18.02	0.66
350	23.37	28.53	9.98	15.62	1.10	0.73	31.20	18.24	0.69
400	22.96	28.32	10.19	15.22	1.11	0.74	31.39	18.01	0.74
450	22.53	28.03	10.42	14.91	1.12	0.74	31.48	18.19	0.73
500	22.10	27.83	10.65	14.66	1.13	0.76	31.29	18.39	0.73
550	21.67	27.46	10.84	14.43	1.14	0.76	31.55	18.12	0.73
650	20.84	26.91	11.29	14.18	1.15	0.78	31.59	18.39	0.72
700	20.43	26.50	11.45	14.12	1.15	0.78	32.02	18.53	0.69
750	20.02	26.16	11.67	14.02	1.15	0.78	32.06	18.68	0.78
800	19.63	25.85	11.80	13.93	1.16	0.79	32.11	18.82	0.78
850	19.25	25.58	11.93	13.69	1.16	0.79	32.37	18.80	0.78
900	18.87	25.27	12.04	13.49	1.16	0.80	32.64	18.96	0.79
950	18.52	24.93	12.16	13.30	1.16	0.80	32.40	19.14	0.82
1000	18.18	24.62	12.23	13.18	1.16	0.80	31.88	19.28	0.81
1200	16.90	23.46	12.74	13.13	1.17	0.81	32.67	19.31	0.91
1400	15.76	22.41	13.01	12.70	1.17	0.81	32.49	19.27	0.94
1600	14.77	21.43	13.35	12.72	1.17	0.81	32.94	19.70	0.98
1800	13.86	20.55	13.57	12.41	1.16	0.81	33.22	19.38	1.09
2000	13.07	19.75	13.93	12.35	1.16	0.80	33.67	20.11	1.08
2200	12.30	19.01	14.01	12.22	1.16	0.81	33.40	19.72	1.09
2400	11.64	18.30	14.09	12.19	1.16	0.80	33.81	20.03	1.07
2600	11.02	17.66	14.07	12.26	1.16	0.80	33.31	20.04	1.24
2800	10.45	17.06	13.89	12.33	1.15	0.81	33.13	19.90	1.35
3000	9.93	16.51	13.78	12.48	1.15	0.81	32.42	19.53	1.26
3200	9.45	15.97	13.37	12.62	1.14	0.81	32.79	19.92	1.44
3400	8.96	15.49	13.05	12.79	1.14	0.82	31.77	20.33	1.53
3600	8.54	15.02	12.55	12.91	1.13	0.82	31.93	20.12	1.52
3800	8.11	14.61	12.21	12.97	1.13	0.83	31.67	19.96	1.59
4000	7.71	14.21	11.69	13.05	1.12	0.84	32.51	20.91	1.74

Typical Performance Data

Definitions:

Input Return Loss = -S11 (dB)

Gain(Power Gain) = S21 (dB)

Reverse Isolation = -S12 (dB)

Output Return Loss = -S22 (dB)

TEST CONDITIONS: RF Input Power = -25dBm, Vd = 3.00V, Id = 35.11mA @ Temperature = 25degC

FREQ	Gain	Isolation	Input Return Loss	Output Return Loss	Stability		IP-3 Output	1dB Comp. Output	Noise Figure
					K	Measure			
(MHz)	(dB)	(dB)	(dB)	(dB)	K	Measure	(dBm)	(dBm)	(dB)
50	24.45	29.13	7.26	14.17	0.96	0.81	28.45	16.42	0.59
60	24.25	28.24	7.81	15.12	0.96	0.72	28.79	16.44	0.59
70	24.15	28.37	8.13	15.92	0.99	0.73	28.54	16.50	0.53
80	24.07	28.26	8.39	16.62	1.00	0.72	28.23	16.24	0.58
90	24.00	28.25	8.59	17.20	1.01	0.72	28.21	16.27	0.60
100	23.95	28.20	8.73	17.62	1.02	0.72	28.19	16.11	0.60
150	23.70	28.12	9.18	18.83	1.04	0.72	28.12	16.76	0.49
200	23.45	27.91	9.43	19.26	1.05	0.72	28.10	16.31	0.60
250	23.15	27.73	9.64	19.35	1.06	0.73	28.09	16.45	0.54
300	22.83	27.42	9.83	19.28	1.06	0.72	28.17	16.44	0.64
350	22.48	27.29	10.02	19.26	1.07	0.74	28.16	16.51	0.58
400	22.12	26.91	10.18	19.10	1.07	0.74	28.13	16.17	0.66
450	21.74	26.67	10.37	18.93	1.08	0.75	28.44	16.66	0.65
500	21.35	26.34	10.52	18.87	1.08	0.75	28.28	16.91	0.62
550	20.97	26.02	10.67	18.78	1.09	0.76	28.71	16.75	0.56
650	20.20	25.37	10.99	18.69	1.10	0.76	28.69	16.99	0.62
700	19.82	25.01	11.10	18.64	1.10	0.77	28.86	17.15	0.64
750	19.44	24.70	11.25	18.66	1.10	0.77	28.71	17.28	0.70
800	19.08	24.36	11.38	18.59	1.10	0.77	28.89	17.67	0.67
850	18.73	24.08	11.49	18.43	1.11	0.78	29.20	17.57	0.67
900	18.38	23.77	11.57	18.29	1.11	0.78	29.36	17.77	0.70
950	18.04	23.44	11.67	18.16	1.11	0.78	29.20	18.04	0.70
1000	17.72	23.15	11.74	18.04	1.11	0.78	28.88	18.18	0.67
1200	16.49	22.04	12.04	18.01	1.12	0.79	29.60	18.33	0.82
1400	15.40	20.96	12.25	17.68	1.12	0.79	29.71	18.48	0.81
1600	14.42	20.03	12.50	17.53	1.12	0.79	29.88	18.84	0.80
1800	13.55	19.16	12.63	17.22	1.12	0.79	30.46	18.61	0.88
2000	12.76	18.36	12.88	17.03	1.12	0.79	30.88	19.20	0.89
2200	12.04	17.62	12.94	16.86	1.12	0.79	30.55	19.01	0.86
2400	11.38	16.93	12.99	16.85	1.11	0.78	30.98	19.17	0.90
2600	10.78	16.32	13.02	16.89	1.11	0.78	31.12	19.26	0.97
2800	10.22	15.74	12.88	17.07	1.11	0.78	30.89	19.19	1.07
3000	9.71	15.19	12.88	17.12	1.11	0.78	31.17	18.99	0.99
3200	9.23	14.65	12.46	17.37	1.10	0.78	31.27	19.32	1.18
3400	8.77	14.19	12.16	17.89	1.10	0.79	31.33	19.38	1.19
3600	8.35	13.75	11.70	17.96	1.10	0.79	31.07	19.46	1.12
3800	7.94	13.33	11.28	18.54	1.09	0.80	31.36	19.52	1.30
4000	7.53	12.97	10.75	18.30	1.09	0.81	31.62	19.95	1.35

Typical Performance Data

Definitions:

Input Return Loss = -S11 (dB)

Gain(Power Gain) = S21 (dB)

Reverse Isolation = -S12 (dB)

Output Return Loss = -S22 (dB)

TEST CONDITIONS: RF Input Power = -25dBm, Vd = 2.7V, Id = 31.15mA @ Temperature = 25degC

FREQ	Gain	Isolation	Input Return Loss	Output Return Loss	Stability		IP-3 Output	1dB Comp. Output	Noise Figure
					K	Measure			
(MHz)	(dB)	(dB)	(dB)	(dB)	K	Measure	(dBm)	(dBm)	(dB)
50	24.13	27.50	7.28	14.03	0.92	0.68	27.53	15.62	0.59
60	23.93	28.11	7.60	14.77	0.97	0.73	27.82	15.65	0.59
70	23.83	28.08	7.93	15.55	0.99	0.73	27.59	15.60	0.54
80	23.75	28.14	8.19	16.26	1.00	0.74	27.28	15.35	0.59
90	23.68	28.03	8.41	16.81	1.01	0.73	27.17	15.31	0.61
100	23.62	27.95	8.53	17.22	1.02	0.73	27.15	15.18	0.61
150	23.39	27.87	9.01	18.49	1.04	0.73	27.10	15.64	0.54
200	23.14	27.59	9.22	18.90	1.04	0.73	27.07	15.39	0.58
250	22.85	27.35	9.39	19.07	1.05	0.73	27.05	15.57	0.56
300	22.54	27.11	9.59	19.16	1.05	0.73	27.06	15.55	0.60
350	22.19	26.90	9.77	19.23	1.06	0.74	27.02	15.79	0.62
400	21.84	26.60	9.92	19.19	1.06	0.75	26.99	15.25	0.65
450	21.47	26.30	10.08	19.17	1.07	0.75	27.26	15.78	0.66
500	21.10	25.92	10.23	19.17	1.07	0.75	27.08	16.13	0.63
550	20.72	25.67	10.38	19.16	1.07	0.76	27.53	15.91	0.60
650	19.96	25.07	10.68	19.26	1.08	0.77	27.47	16.19	0.63
700	19.59	24.67	10.79	19.25	1.08	0.77	27.62	16.26	0.66
750	19.22	24.39	10.93	19.36	1.09	0.78	27.48	16.38	0.69
800	18.86	24.05	11.05	19.30	1.09	0.78	27.64	16.72	0.70
850	18.51	23.75	11.15	19.19	1.09	0.78	27.95	16.67	0.68
900	18.17	23.46	11.24	19.06	1.09	0.79	28.08	16.97	0.68
950	17.83	23.14	11.32	18.97	1.10	0.79	27.93	17.20	0.69
1000	17.51	22.85	11.37	18.92	1.10	0.79	27.68	17.36	0.66
1200	16.29	21.71	11.67	19.02	1.10	0.79	28.38	17.42	0.82
1400	15.21	20.69	11.86	18.72	1.11	0.79	28.48	17.62	0.83
1600	14.24	19.75	12.08	18.67	1.11	0.79	28.61	17.98	0.83
1800	13.38	18.89	12.21	18.35	1.11	0.79	29.28	17.76	0.91
2000	12.60	18.10	12.43	18.20	1.11	0.79	29.65	18.29	0.89
2200	11.87	17.35	12.50	18.01	1.11	0.79	29.33	18.16	0.85
2400	11.22	16.69	12.54	18.05	1.11	0.79	29.85	18.40	0.88
2600	10.62	16.06	12.57	18.07	1.11	0.78	29.85	18.36	0.97
2800	10.06	15.49	12.43	18.32	1.11	0.79	29.72	18.37	1.10
3000	9.56	14.96	12.41	18.35	1.11	0.78	29.96	18.15	0.96
3200	9.08	14.43	12.02	18.64	1.10	0.79	30.09	18.50	1.12
3400	8.62	13.98	11.74	19.19	1.10	0.79	30.13	18.56	1.23
3600	8.20	13.53	11.30	19.21	1.09	0.79	29.95	18.61	1.18
3800	7.79	13.12	10.89	19.68	1.09	0.80	30.29	18.71	1.26
4000	7.37	12.77	10.37	19.27	1.09	0.81	30.39	19.14	1.38

Typical Performance Data

Definitions:

Input Return Loss = -S11 (dB)

Gain(Power Gain) = S21 (dB)

Reverse Isolation = -S12 (dB)

Output Return Loss = -S22 (dB)

TEST CONDITIONS: RF Input Power = -25dBm, Vd = 3.3V, Id = 38.52mA @ Temperature = 25degC

FREQ	Gain	Isolation	Input Return Loss	Output Return Loss	Stability		IP-3 Output	1dB Comp. Output	Noise Figure
					K	Measure			
(MHz)	(dB)	(dB)	(dB)	(dB)	K	Measure	(dBm)	(dBm)	(dB)
50	24.69	28.88	7.69	14.58	0.94	0.76	29.44	17.28	0.60
60	24.49	28.20	8.14	15.64	0.96	0.69	29.84	17.46	0.60
70	24.39	28.46	8.54	16.54	0.99	0.71	29.63	17.39	0.53
80	24.30	28.39	8.83	17.36	1.01	0.71	29.24	17.15	0.57
90	24.23	28.32	9.05	18.05	1.01	0.70	29.18	17.17	0.60
100	24.17	28.31	9.20	18.58	1.02	0.70	29.15	17.01	0.62
150	23.93	28.25	9.72	20.08	1.05	0.71	29.11	17.46	0.50
200	23.66	27.95	9.97	20.42	1.05	0.70	29.14	17.11	0.59
250	23.36	27.77	10.17	20.33	1.06	0.70	29.10	17.36	0.52
300	23.03	27.58	10.38	20.05	1.07	0.71	29.21	17.22	0.55
350	22.68	27.33	10.57	19.76	1.08	0.71	29.17	17.48	0.62
400	22.32	27.16	10.72	19.47	1.09	0.73	29.19	17.04	0.64
450	21.93	26.81	10.91	19.17	1.09	0.73	29.53	17.49	0.64
500	21.55	26.57	11.05	18.93	1.10	0.74	29.37	17.77	0.63
550	21.16	26.26	11.20	18.71	1.10	0.75	29.80	17.59	0.58
650	20.38	25.65	11.52	18.38	1.11	0.76	29.84	17.95	0.63
700	20.00	25.29	11.62	18.27	1.11	0.76	29.98	17.97	0.59
750	19.63	24.99	11.77	18.22	1.12	0.76	29.87	18.18	0.68
800	19.26	24.65	11.89	18.13	1.12	0.77	29.99	18.43	0.68
850	18.91	24.33	12.01	17.91	1.12	0.77	30.33	18.44	0.66
900	18.56	24.03	12.09	17.71	1.12	0.77	30.48	18.68	0.68
950	18.22	23.76	12.18	17.53	1.12	0.78	30.32	18.87	0.68
1000	17.89	23.46	12.23	17.38	1.13	0.78	30.06	19.03	0.69
1200	16.66	22.31	12.54	17.23	1.13	0.78	30.74	19.15	0.79
1400	15.57	21.25	12.72	16.82	1.13	0.79	30.73	19.33	0.81
1600	14.58	20.30	12.98	16.63	1.13	0.79	30.92	19.66	0.80
1800	13.71	19.41	13.11	16.30	1.12	0.79	31.38	19.43	0.87
2000	12.92	18.59	13.36	16.09	1.12	0.78	31.77	19.99	0.87
2200	12.19	17.89	13.41	15.90	1.12	0.78	31.47	19.79	0.88
2400	11.53	17.21	13.46	15.82	1.12	0.78	31.85	20.05	0.86
2600	10.93	16.57	13.51	15.83	1.12	0.78	32.02	20.02	0.97
2800	10.37	15.98	13.35	15.94	1.11	0.78	31.61	19.99	1.05
3000	9.86	15.43	13.35	16.00	1.11	0.78	31.84	19.73	0.96
3200	9.38	14.89	12.93	16.16	1.10	0.78	31.88	20.05	1.11
3400	8.93	14.43	12.62	16.66	1.10	0.78	31.89	20.12	1.18
3600	8.50	13.97	12.14	16.73	1.10	0.79	31.68	20.15	1.15
3800	8.09	13.56	11.68	17.29	1.10	0.80	31.64	20.21	1.21
4000	7.68	13.18	11.12	17.18	1.09	0.80	31.99	20.71	1.41

Typical Performance Data

Definitions:

Input Return Loss = -S11 (dB)

Gain(Power Gain) = S21 (dB)

Reverse Isolation = -S12 (dB)

Output Return Loss = -S22 (dB)

TEST CONDITIONS: RF Input Power = -25dBm, Vd = 3.00V, Id = 38.55mA @ Temperature = -45degC

FREQ	Gain	Isolation	Input Return Loss	Output Return Loss	Stability		IP-3 Output	1dB Comp. Output	Noise Figure
					K	Measure			
(MHz)	(dB)	(dB)	(dB)	(dB)	K	Measure	(dBm)	(dBm)	(dB)
50	24.67	27.40	8.64	14.87	0.90	0.62	29.35	17.84	0.44
60	24.42	28.15	9.26	16.26	0.96	0.70	29.89	17.97	0.44
70	24.28	27.93	9.93	17.76	0.98	0.68	29.68	17.93	0.42
80	24.16	27.78	10.42	19.20	1.00	0.66	29.38	17.88	0.45
90	24.07	27.61	10.80	20.52	1.00	0.65	29.42	17.83	0.47
100	24.00	27.70	11.07	21.78	1.02	0.65	29.40	17.77	0.46
150	23.73	27.56	11.93	27.48	1.05	0.65	29.26	18.14	0.38
200	23.48	27.39	12.26	29.40	1.06	0.65	29.39	17.91	0.46
250	23.21	27.36	12.52	27.96	1.08	0.66	29.39	18.00	0.42
300	22.92	27.10	12.72	25.69	1.08	0.66	29.39	17.89	0.48
350	22.60	26.98	12.88	24.28	1.10	0.67	29.54	18.07	0.47
400	22.28	26.80	13.00	22.93	1.11	0.68	29.53	17.93	0.50
450	21.93	26.58	13.10	21.99	1.11	0.68	29.84	18.01	0.50
500	21.57	26.38	13.16	21.23	1.12	0.69	29.67	18.19	0.48
550	21.21	26.08	13.22	20.50	1.12	0.70	30.13	18.00	0.47
650	20.49	25.58	13.37	19.42	1.14	0.71	30.06	18.18	0.47
700	20.13	25.29	13.42	19.06	1.14	0.72	30.34	18.37	0.45
750	19.77	25.05	13.54	18.85	1.14	0.73	30.17	18.46	0.52
800	19.44	24.74	13.59	18.62	1.14	0.73	30.36	18.58	0.51
850	19.10	24.42	13.67	18.38	1.14	0.73	30.71	18.53	0.51
900	18.76	24.16	13.70	18.23	1.14	0.74	30.90	18.67	0.48
950	18.44	23.89	13.73	17.97	1.15	0.74	30.67	18.67	0.55
1000	18.12	23.59	13.70	17.76	1.14	0.75	30.40	18.84	0.50
1200	16.93	22.45	13.78	17.26	1.14	0.75	31.21	18.91	0.62
1400	15.87	21.41	13.83	16.87	1.14	0.76	31.23	19.05	0.60
1600	14.90	20.50	13.87	16.58	1.13	0.76	31.50	19.38	0.63
1800	14.05	19.61	13.91	16.21	1.13	0.76	32.15	19.21	0.70
2000	13.27	18.81	14.05	15.97	1.12	0.76	32.62	19.61	0.63
2200	12.55	18.06	14.15	15.61	1.12	0.76	32.33	19.49	0.62
2400	11.90	17.38	14.16	15.56	1.11	0.76	32.90	19.66	0.61
2600	11.30	16.74	14.20	15.28	1.11	0.76	32.93	19.66	0.73
2800	10.76	16.12	14.12	15.41	1.10	0.75	32.61	19.62	0.81
3000	10.23	15.60	14.17	15.31	1.10	0.75	32.99	19.38	0.72
3200	9.78	15.05	13.69	15.52	1.09	0.75	33.27	19.65	0.87
3400	9.33	14.57	13.33	15.88	1.09	0.76	33.20	19.70	0.87
3600	8.93	14.10	12.92	16.04	1.08	0.76	33.02	19.80	0.87
3800	8.52	13.67	12.28	16.88	1.08	0.77	33.33	19.82	0.84
4000	8.13	13.29	11.53	17.29	1.07	0.78	33.94	20.23	0.90

Typical Performance Data

Definitions:

Input Return Loss = -S11 (dB)

Gain(Power Gain) = S21 (dB)

Reverse Isolation = -S12 (dB)

Output Return Loss = -S22 (dB)

TEST CONDITIONS: RF Input Power = -25dBm, Vd = 2.7V, Id = 39.41mA @ Temperature = -45degC

FREQ	Gain	Isolation	Input Return Loss	Output Return Loss	Stability		IP-3 Output	1dB Comp. Output	Noise Figure
					K	Measure			
(MHz)	(dB)	(dB)	(dB)	(dB)			(dBm)	(dBm)	(dB)
50	24.42	27.08	8.45	14.76	0.90	0.61	28.16	16.72	0.45
60	24.17	27.71	9.02	16.10	0.95	0.68	28.57	16.82	0.45
70	24.03	27.65	9.62	17.40	0.98	0.68	28.38	16.76	0.40
80	23.91	27.64	10.07	18.77	1.00	0.68	28.10	16.62	0.46
90	23.82	27.55	10.44	19.95	1.01	0.67	28.14	16.62	0.49
100	23.75	27.54	10.69	21.07	1.02	0.67	28.13	16.52	0.50
150	23.49	27.46	11.44	25.76	1.05	0.67	28.06	16.96	0.39
200	23.24	27.22	11.79	27.92	1.06	0.66	28.04	16.68	0.45
250	22.98	27.12	12.00	27.75	1.07	0.67	28.10	16.85	0.39
300	22.69	26.97	12.23	26.44	1.08	0.67	28.12	16.72	0.48
350	22.38	26.73	12.40	25.44	1.09	0.68	28.15	17.03	0.48
400	22.06	26.57	12.48	24.22	1.10	0.69	28.11	16.67	0.48
450	21.72	26.41	12.58	23.34	1.11	0.70	28.33	16.94	0.52
500	21.36	26.13	12.64	22.60	1.11	0.70	28.22	17.14	0.50
550	21.01	25.89	12.70	21.96	1.12	0.71	28.65	16.99	0.46
650	20.29	25.31	12.85	20.87	1.12	0.72	28.56	17.17	0.46
700	19.94	24.99	12.89	20.46	1.13	0.72	28.78	17.34	0.43
750	19.58	24.72	13.00	20.29	1.13	0.73	28.67	17.42	0.74
800	19.25	24.41	13.06	20.10	1.13	0.73	28.83	17.59	0.53
850	18.91	24.13	13.13	19.90	1.13	0.74	29.13	17.58	0.50
900	18.58	23.87	13.16	19.66	1.13	0.74	29.31	17.68	0.49
950	18.26	23.55	13.19	19.45	1.13	0.75	29.05	17.72	0.50
1000	17.94	23.25	13.17	19.21	1.13	0.75	28.81	17.92	0.50
1200	16.76	22.16	13.23	18.77	1.13	0.76	29.59	17.94	0.62
1400	15.70	21.13	13.30	18.34	1.13	0.76	29.63	18.08	0.61
1600	14.74	20.19	13.33	18.06	1.13	0.77	29.87	18.40	0.60
1800	13.89	19.31	13.36	17.67	1.12	0.77	30.52	18.25	0.67
2000	13.12	18.49	13.49	17.48	1.12	0.76	30.94	18.67	0.66
2200	12.40	17.77	13.57	17.04	1.11	0.76	30.57	18.56	0.63
2400	11.75	17.08	13.60	17.00	1.11	0.76	31.21	18.75	0.61
2600	11.16	16.44	13.64	16.74	1.10	0.76	30.97	18.66	0.73
2800	10.62	15.83	13.54	16.93	1.10	0.75	30.90	18.69	0.79
3000	10.09	15.30	13.58	16.83	1.10	0.75	30.79	18.46	0.77
3200	9.64	14.74	13.12	17.15	1.09	0.75	31.13	18.83	0.86
3400	9.18	14.26	12.78	17.62	1.08	0.76	30.53	18.85	0.80
3600	8.79	13.82	12.36	17.88	1.08	0.76	30.65	18.92	0.83
3800	8.37	13.38	11.77	18.84	1.08	0.77	30.74	18.93	0.86
4000	7.98	12.99	11.05	19.44	1.07	0.78	31.19	19.30	0.98

Typical Performance Data

Definitions:

Input Return Loss = -S11 (dB)

Gain(Power Gain) = S21 (dB)

Reverse Isolation = -S12 (dB)

Output Return Loss = -S22 (dB)

TEST CONDITIONS: RF Input Power = -25dBm, Vd = 3.3V, Id = 46.36mA @ Temperature = -45degC

FREQ	Gain	Isolation	Input Return Loss	Output Return Loss	Stability		IP-3 Output	1dB Comp. Output	Noise Figure
					K	Measure			
(MHz)	(dB)	(dB)	(dB)	(dB)			(dBm)	(dBm)	(dB)
50	24.83	29.06	8.80	14.85	0.95	0.76	30.10	17.77	0.46
60	24.58	28.00	9.52	16.47	0.95	0.67	30.58	18.26	0.46
70	24.43	27.96	10.18	17.96	0.98	0.66	30.44	18.26	0.42
80	24.31	27.80	10.67	19.43	0.99	0.65	30.04	18.00	0.47
90	24.22	27.69	11.07	20.88	1.01	0.64	30.14	18.05	0.49
100	24.15	27.77	11.37	22.25	1.02	0.64	30.22	17.95	0.49
150	23.88	27.57	12.22	28.90	1.04	0.63	29.96	18.50	0.38
200	23.62	27.47	12.61	30.80	1.06	0.64	30.09	18.04	0.46
250	23.35	27.43	12.90	28.08	1.08	0.65	30.17	18.33	0.41
300	23.06	27.30	13.10	25.41	1.09	0.66	30.22	18.08	0.45
350	22.73	27.09	13.28	23.69	1.10	0.66	30.26	18.41	0.50
400	22.40	27.00	13.36	22.32	1.11	0.68	30.21	17.98	0.50
450	22.05	26.71	13.46	21.33	1.12	0.68	30.67	18.39	0.50
500	21.69	26.57	13.52	20.55	1.13	0.69	30.45	18.66	0.52
550	21.33	26.28	13.58	19.85	1.13	0.70	30.99	18.50	0.43
650	20.60	25.75	13.73	18.76	1.14	0.71	31.00	18.69	0.46
700	20.24	25.46	13.75	18.39	1.14	0.72	31.11	18.82	0.44
750	19.88	25.19	13.88	18.11	1.15	0.72	30.99	18.92	0.52
800	19.54	24.86	13.94	17.93	1.15	0.72	31.16	19.20	0.50
850	19.20	24.60	14.00	17.71	1.15	0.73	31.54	19.16	0.49
900	18.87	24.28	14.03	17.50	1.15	0.73	31.75	19.36	0.49
950	18.54	24.05	14.06	17.28	1.15	0.74	31.56	19.41	0.51
1000	18.22	23.75	14.02	17.06	1.15	0.74	31.26	19.57	0.54
1200	17.02	22.65	14.08	16.54	1.15	0.75	31.95	19.66	0.59
1400	15.96	21.62	14.15	16.16	1.14	0.76	32.10	19.78	0.63
1600	14.99	20.67	14.18	15.86	1.14	0.76	32.18	20.11	0.60
1800	14.14	19.79	14.21	15.49	1.13	0.76	32.66	19.93	0.66
2000	13.35	18.99	14.36	15.28	1.13	0.76	32.95	20.38	0.62
2200	12.63	18.25	14.44	14.89	1.12	0.76	32.78	20.24	0.59
2400	11.98	17.54	14.48	14.85	1.12	0.76	33.17	20.42	0.63
2600	11.38	16.91	14.52	14.57	1.11	0.76	33.33	20.39	0.76
2800	10.84	16.30	14.43	14.69	1.11	0.75	32.86	20.38	0.78
3000	10.31	15.78	14.48	14.61	1.10	0.75	33.41	20.13	0.67
3200	9.86	15.18	13.98	14.75	1.09	0.75	33.38	20.51	0.79
3400	9.40	14.73	13.60	15.07	1.09	0.76	33.75	20.50	0.85
3600	9.01	14.27	13.18	15.20	1.08	0.76	33.34	20.54	0.81
3800	8.59	13.84	12.54	15.94	1.08	0.77	33.32	20.57	0.86
4000	8.21	13.43	11.77	16.30	1.07	0.78	33.50	21.03	1.10

Typical Performance Data

Definitions:

Input Return Loss = -S11 (dB)

Gain(Power Gain) = S21 (dB)

Reverse Isolation = -S12 (dB)

Output Return Loss = -S22 (dB)

TEST CONDITIONS: RF Input Power = -25dBm, Vd = 3.00V, Id = 34.09mA @ Temperature = 85degC

FREQ	Gain	Isolation	Input Return Loss	Output Return Loss	Stability		IP-3 Output	1dB Comp. Output	Noise Figure
					K	Measure			
(MHz)	(dB)	(dB)	(dB)	(dB)	K	Measure	(dBm)	(dBm)	(dB)
50	24.26	29.16	6.53	12.90	0.98	0.78	28.35	16.02	0.68
60	24.09	28.37	6.84	13.44	0.97	0.72	28.69	15.91	0.68
70	24.00	28.75	7.11	13.90	1.00	0.76	28.34	15.87	0.64
80	23.93	28.65	7.29	14.32	1.01	0.75	27.95	15.66	0.67
90	23.87	28.62	7.43	14.62	1.02	0.75	27.85	15.66	0.68
100	23.83	28.53	7.52	14.83	1.02	0.75	27.83	15.53	0.66
150	23.61	28.51	7.91	15.55	1.04	0.76	27.78	15.98	0.60
200	23.35	28.14	8.14	15.80	1.04	0.75	27.77	15.68	0.63
250	23.05	27.96	8.33	15.96	1.05	0.76	27.73	15.85	0.60
300	22.71	27.54	8.54	15.99	1.04	0.75	27.75	15.82	0.68
350	22.35	27.29	8.75	16.10	1.05	0.76	27.72	16.07	0.66
400	21.98	26.95	8.94	16.09	1.05	0.77	27.75	15.61	0.70
450	21.59	26.64	9.14	16.09	1.05	0.77	28.01	16.04	0.71
500	21.20	26.33	9.35	16.15	1.06	0.78	27.83	16.26	0.69
550	20.81	25.94	9.53	16.21	1.06	0.78	28.24	16.21	0.69
650	20.03	25.22	9.94	16.45	1.06	0.78	28.22	16.46	0.70
700	19.65	24.96	10.11	16.58	1.07	0.79	28.37	16.55	0.71
750	19.26	24.63	10.31	16.66	1.08	0.80	28.23	16.65	0.74
800	18.89	24.35	10.45	16.65	1.08	0.80	28.39	17.06	0.76
850	18.53	24.00	10.59	16.51	1.08	0.80	28.70	17.01	0.78
900	18.17	23.69	10.67	16.37	1.08	0.81	28.81	17.20	0.78
950	17.83	23.41	10.79	16.28	1.09	0.81	28.68	17.55	0.78
1000	17.51	23.11	10.86	16.30	1.09	0.81	28.33	17.66	0.80
1200	16.27	21.98	11.36	16.60	1.10	0.81	29.07	17.82	0.92
1400	15.17	20.99	11.61	16.28	1.11	0.81	29.11	17.99	0.93
1600	14.20	20.05	11.93	16.55	1.12	0.81	29.25	18.37	0.97
1800	13.32	19.17	12.16	16.19	1.12	0.81	29.83	18.07	1.06
2000	12.54	18.38	12.46	16.30	1.12	0.81	30.18	18.76	1.03
2200	11.80	17.70	12.56	16.19	1.13	0.81	29.90	18.50	1.05
2400	11.15	17.01	12.60	16.34	1.13	0.81	30.31	18.80	1.03
2600	10.53	16.37	12.60	16.48	1.12	0.81	30.40	18.78	1.14
2800	9.98	15.82	12.43	16.79	1.13	0.81	30.10	18.71	1.23
3000	9.46	15.28	12.33	17.06	1.13	0.81	30.37	18.55	1.09
3200	8.97	14.76	11.95	17.34	1.12	0.81	30.43	18.84	1.38
3400	8.50	14.31	11.68	17.56	1.12	0.82	30.53	18.95	1.46
3600	8.07	13.86	11.24	17.76	1.11	0.82	30.28	19.02	1.32
3800	7.65	13.47	10.95	17.58	1.11	0.83	30.34	19.09	1.47
4000	7.25	13.09	10.49	17.63	1.11	0.83	30.58	19.61	1.62

Typical Performance Data

Definitions:

Input Return Loss = -S11 (dB)

Gain(Power Gain) = S21 (dB)

Reverse Isolation = -S12 (dB)

Output Return Loss = -S22 (dB)

TEST CONDITIONS: RF Input Power = -25dBm, Vd = 2.7V, Id = 30.24mA @ Temperature = 85degC

FREQ	Gain	Isolation	Input Return Loss	Output Return Loss	Stability		IP-3 Output	1dB Comp. Output	Noise Figure
					K	Measure			
(MHz)	(dB)	(dB)	(dB)	(dB)	K	Measure	(dBm)	(dBm)	(dB)
50	23.92	28.03	6.37	12.58	0.94	0.72	27.39	15.27	0.66
60	23.74	28.33	6.65	13.02	0.97	0.76	27.66	15.02	0.66
70	23.67	28.35	6.84	13.46	0.99	0.76	27.32	15.03	0.63
80	23.59	28.47	7.01	13.84	1.01	0.77	26.99	14.78	0.66
90	23.54	28.29	7.16	14.12	1.01	0.76	26.90	14.79	0.69
100	23.49	28.34	7.25	14.32	1.02	0.76	26.83	14.64	0.70
150	23.28	28.12	7.62	14.97	1.03	0.76	26.77	15.23	0.63
200	23.03	27.87	7.83	15.26	1.03	0.76	26.72	14.87	0.65
250	22.73	27.60	8.02	15.45	1.03	0.76	26.64	14.93	0.62
300	22.41	27.29	8.22	15.61	1.03	0.77	26.68	15.02	0.62
350	22.06	27.02	8.41	15.73	1.03	0.78	26.60	15.08	0.67
400	21.70	26.61	8.60	15.79	1.03	0.78	26.58	14.74	0.74
450	21.32	26.24	8.79	15.85	1.03	0.78	26.80	15.32	0.73
500	20.93	25.90	8.99	15.98	1.03	0.78	26.66	15.45	0.72
550	20.54	25.61	9.17	16.10	1.04	0.79	27.05	15.36	0.66
650	19.78	24.93	9.58	16.49	1.05	0.80	27.03	15.62	0.71
700	19.40	24.60	9.73	16.69	1.05	0.80	27.16	15.72	0.71
750	19.02	24.25	9.94	16.80	1.06	0.80	27.02	15.80	0.79
800	18.66	23.97	10.07	16.84	1.06	0.81	27.16	16.16	0.79
850	18.30	23.66	10.19	16.74	1.06	0.81	27.49	16.21	0.76
900	17.95	23.37	10.29	16.62	1.07	0.81	27.60	16.40	0.79
950	17.61	23.10	10.40	16.65	1.07	0.82	27.42	16.75	0.79
1000	17.29	22.78	10.48	16.67	1.07	0.81	27.14	16.84	0.78
1200	16.07	21.67	10.94	17.14	1.09	0.82	27.85	16.99	0.92
1400	14.97	20.68	11.20	16.94	1.10	0.82	27.93	17.18	0.95
1600	14.01	19.74	11.50	17.30	1.11	0.82	28.10	17.57	0.94
1800	13.13	18.93	11.72	16.99	1.11	0.82	28.74	17.29	1.02
2000	12.35	18.13	12.01	17.15	1.12	0.81	29.14	17.91	1.05
2200	11.61	17.44	12.10	17.06	1.12	0.81	28.80	17.71	1.04
2400	10.97	16.77	12.14	17.31	1.12	0.81	29.31	18.07	1.02
2600	10.36	16.15	12.13	17.44	1.12	0.81	29.38	17.98	1.14
2800	9.80	15.58	11.97	17.86	1.12	0.81	29.17	17.83	1.24
3000	9.29	15.05	11.89	18.13	1.12	0.81	29.48	17.76	1.13
3200	8.81	14.53	11.55	18.42	1.12	0.82	29.57	18.04	1.33
3400	8.33	14.08	11.28	18.61	1.12	0.82	29.67	18.17	1.43
3600	7.90	13.67	10.85	18.68	1.11	0.83	29.45	18.17	1.44
3800	7.49	13.27	10.57	18.44	1.11	0.83	29.68	18.31	1.45
4000	7.08	12.89	10.12	18.32	1.11	0.84	29.79	18.78	1.67

Typical Performance Data

Definitions:

Input Return Loss = -S11 (dB)

Gain(Power Gain) = S21 (dB)

Reverse Isolation = -S12 (dB)

Output Return Loss = -S22 (dB)

TEST CONDITIONS: RF Input Power = -25dBm, Vd = 3.3V, Id = 37.88mA @ Temperature = 85degC

FREQ	Gain	Isolation	Input Return Loss	Output Return Loss	Stability		IP-3 Output	1dB Comp. Output	Noise Figure
					K	Measure			
(MHz)	(dB)	(dB)	(dB)	(dB)	K	Measure	(dBm)	(dBm)	(dB)
50	24.54	30.06	6.77	13.17	1.01	0.84	29.33	16.41	0.66
60	24.37	28.97	7.13	13.75	0.98	0.76	29.62	16.55	0.66
70	24.29	28.80	7.34	14.29	1.00	0.74	29.26	16.62	0.61
80	24.21	28.74	7.53	14.71	1.01	0.74	28.89	16.40	0.65
90	24.15	28.70	7.69	15.03	1.02	0.73	28.86	16.40	0.66
100	24.11	28.62	7.78	15.26	1.02	0.73	28.76	16.30	0.66
150	23.88	28.57	8.19	16.05	1.04	0.74	28.66	16.89	0.61
200	23.61	28.29	8.41	16.22	1.04	0.73	28.74	16.45	0.65
250	23.30	28.06	8.63	16.31	1.05	0.74	28.68	16.55	0.58
300	22.96	27.78	8.83	16.28	1.05	0.74	28.78	16.57	0.62
350	22.60	27.49	9.07	16.33	1.06	0.75	28.76	16.66	0.66
400	22.21	27.27	9.24	16.23	1.07	0.76	28.75	16.36	0.72
450	21.82	26.94	9.47	16.13	1.07	0.77	29.07	16.83	0.70
500	21.42	26.54	9.67	16.13	1.07	0.77	28.84	17.05	0.68
550	21.02	26.29	9.85	16.12	1.08	0.78	29.30	16.94	0.68
650	20.23	25.66	10.28	16.22	1.09	0.79	29.31	17.18	0.71
700	19.84	25.30	10.45	16.31	1.09	0.79	29.45	17.34	0.69
750	19.45	24.98	10.65	16.34	1.10	0.79	29.28	17.27	0.77
800	19.08	24.67	10.78	16.34	1.10	0.80	29.43	17.64	0.75
850	18.71	24.33	10.93	16.15	1.10	0.80	29.76	17.68	0.76
900	18.36	23.98	11.01	15.97	1.10	0.80	29.87	17.95	0.79
950	18.01	23.69	11.15	15.83	1.10	0.80	29.77	18.22	0.75
1000	17.68	23.40	11.22	15.77	1.11	0.80	29.43	18.35	0.80
1200	16.44	22.27	11.70	15.98	1.12	0.81	30.05	18.57	0.88
1400	15.33	21.25	11.97	15.62	1.12	0.81	30.02	18.63	0.89
1600	14.36	20.29	12.29	15.77	1.13	0.81	30.29	19.04	0.96
1800	13.47	19.47	12.52	15.43	1.13	0.81	30.63	18.73	1.06
2000	12.69	18.65	12.82	15.47	1.13	0.81	30.94	19.46	1.06
2200	11.94	17.94	12.93	15.34	1.13	0.81	30.68	19.13	1.06
2400	11.29	17.27	12.98	15.44	1.13	0.81	30.94	19.51	1.00
2600	10.67	16.62	12.97	15.58	1.13	0.80	31.06	19.48	1.13
2800	10.11	16.04	12.82	15.82	1.13	0.81	30.68	19.36	1.25
3000	9.59	15.48	12.71	16.04	1.13	0.81	30.85	19.21	1.12
3200	9.11	14.98	12.33	16.33	1.12	0.81	30.89	19.48	1.33
3400	8.64	14.51	12.04	16.55	1.12	0.82	30.85	19.62	1.47
3600	8.21	14.09	11.59	16.76	1.12	0.82	30.60	19.67	1.42
3800	7.79	13.68	11.28	16.64	1.11	0.83	30.38	19.73	1.51
4000	7.38	13.28	10.80	16.79	1.11	0.83	30.71	20.27	1.73

Typical Performance Curves

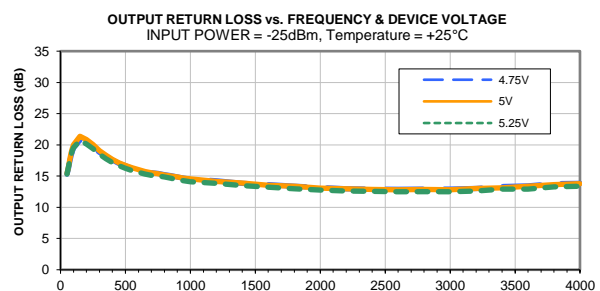
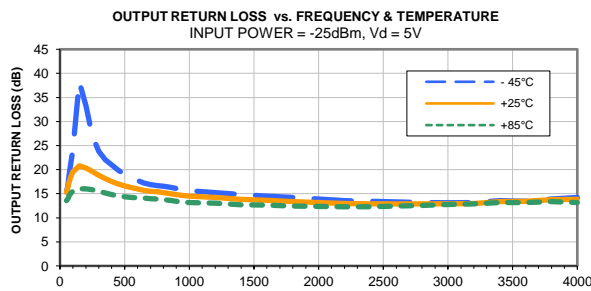
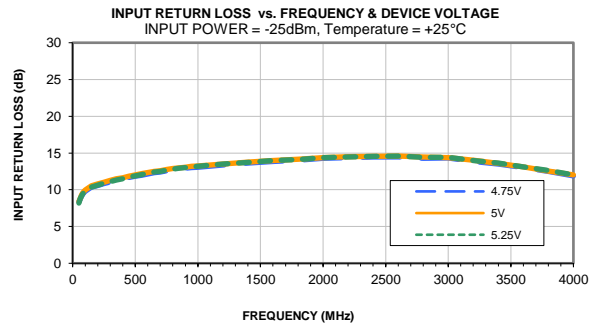
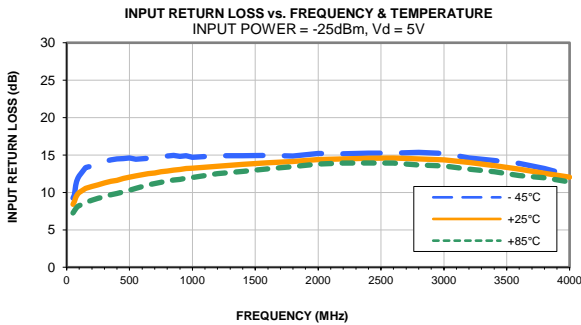
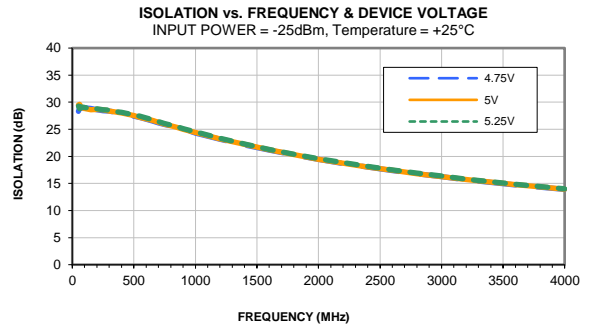
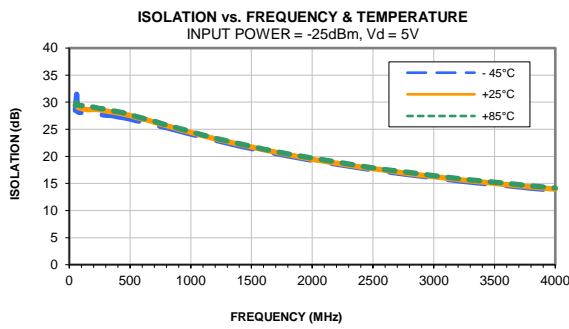
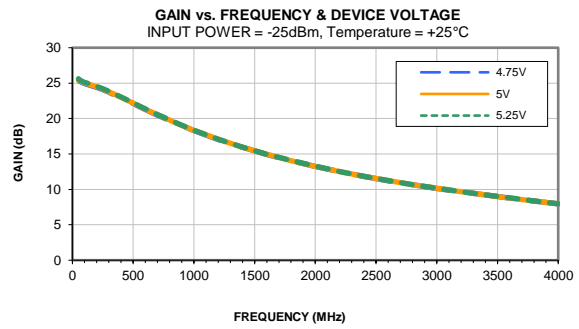
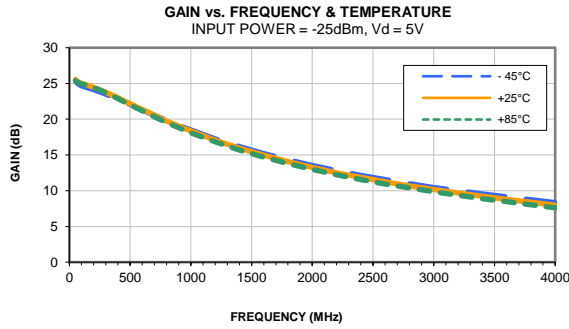

Typical Performance Curves

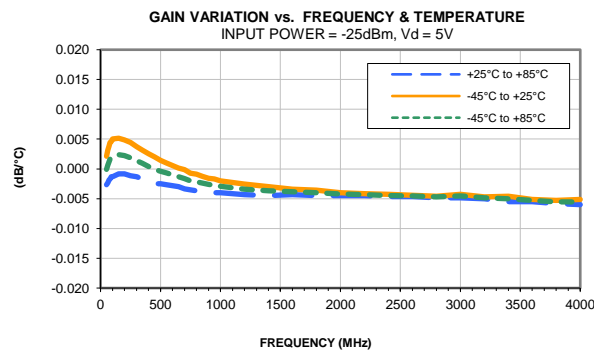
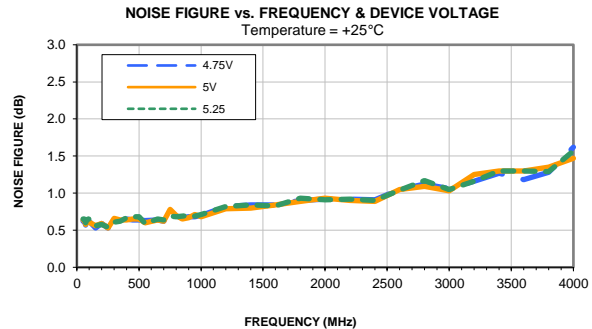
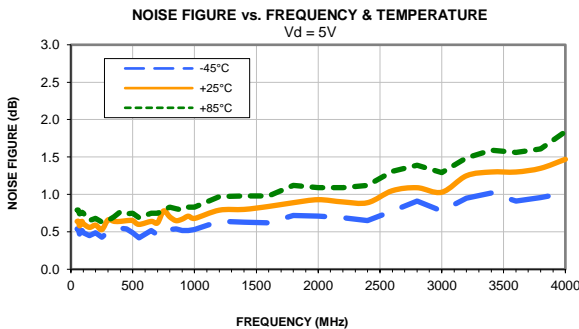
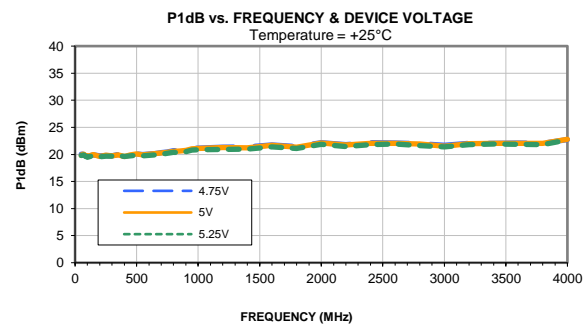
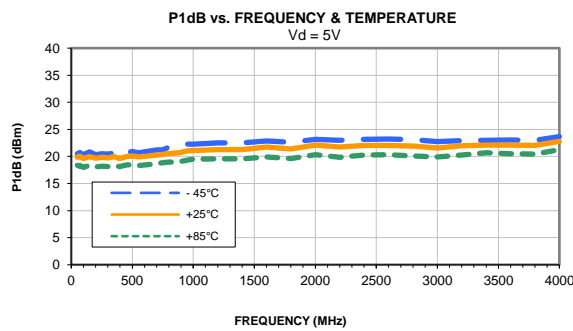
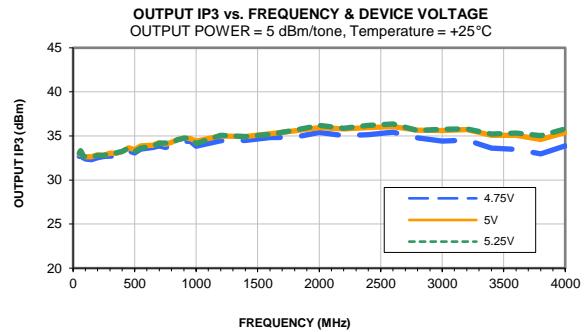
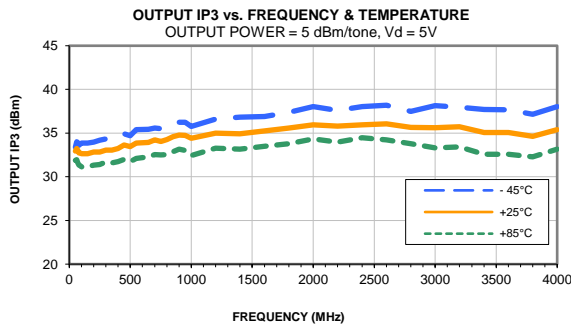

Typical Performance Curves

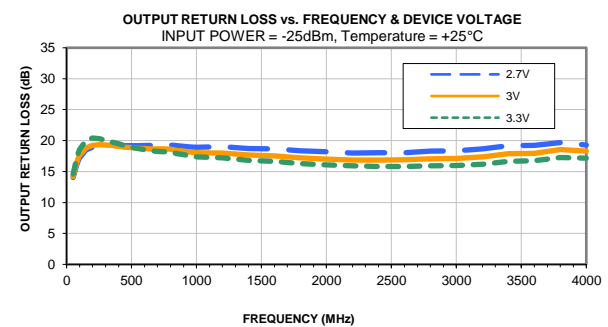
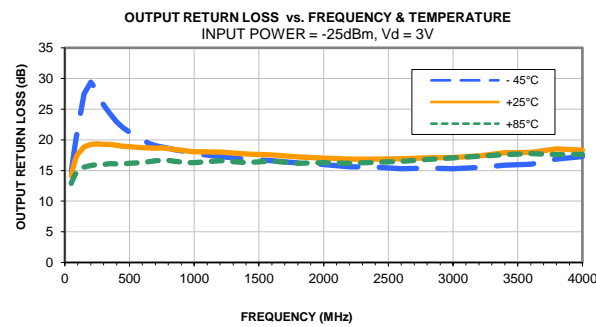
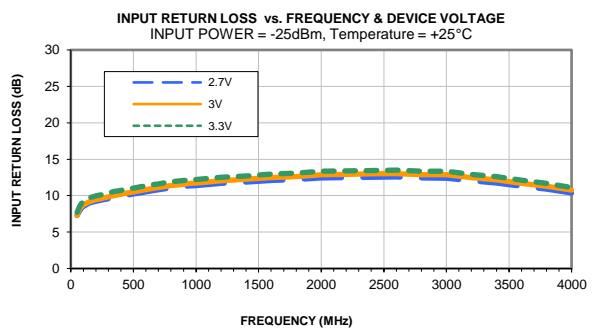
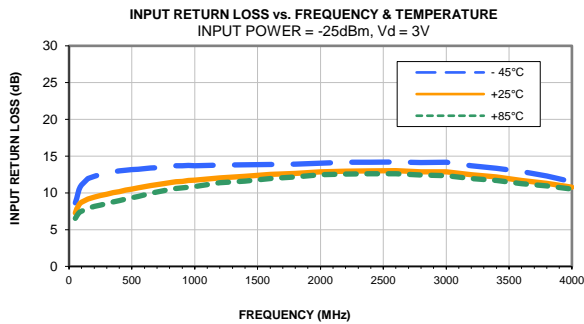
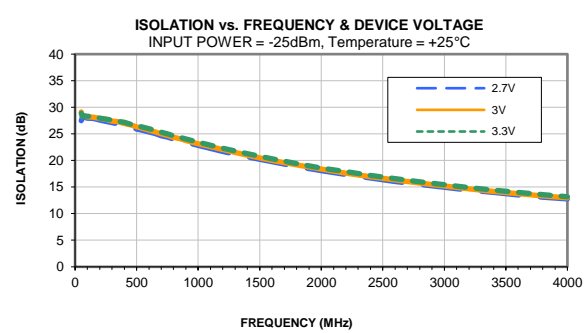
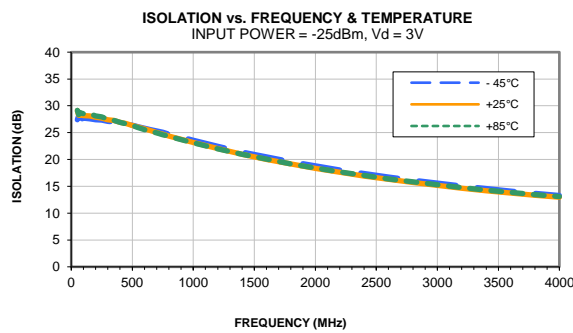
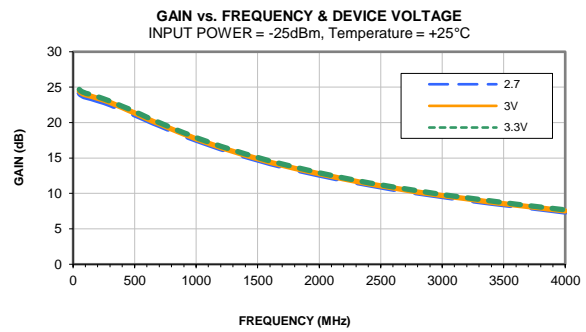
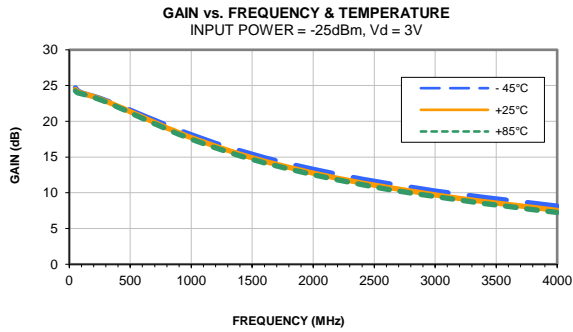

Typical Performance Curves

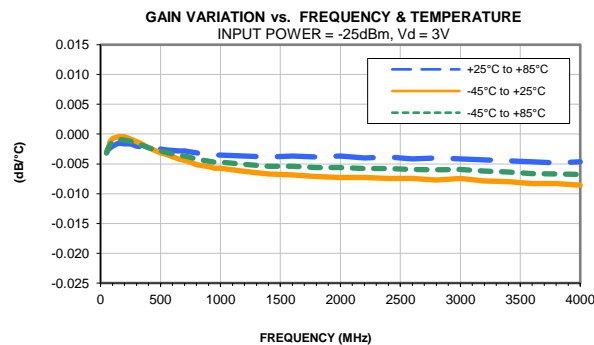
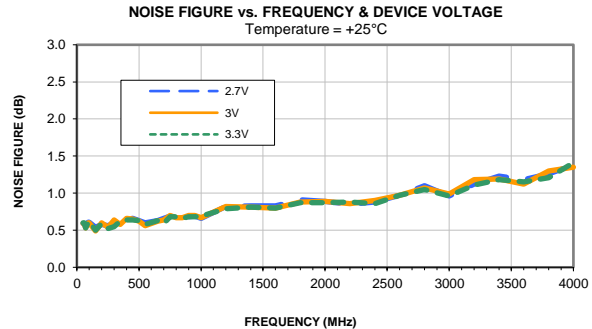
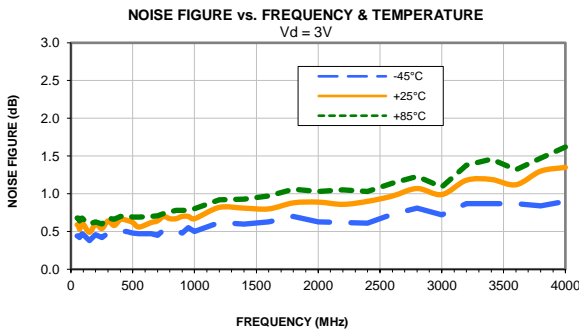
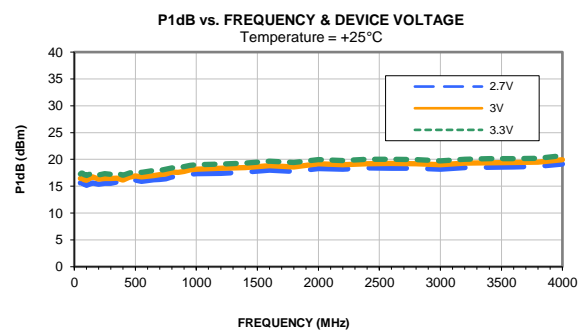
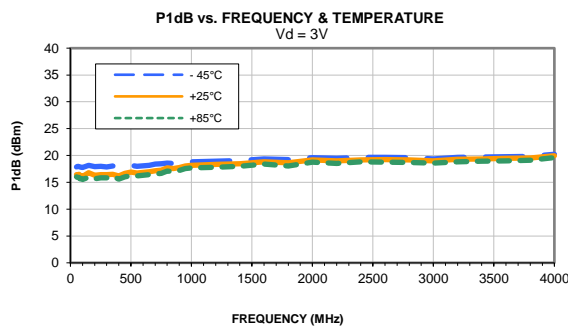
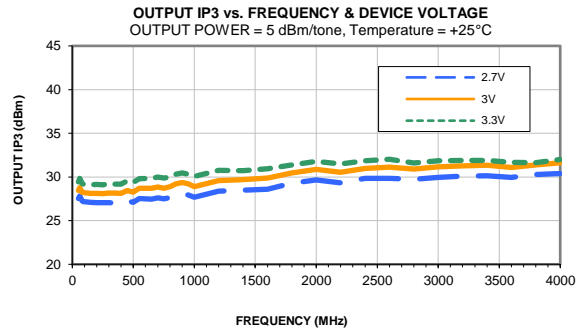
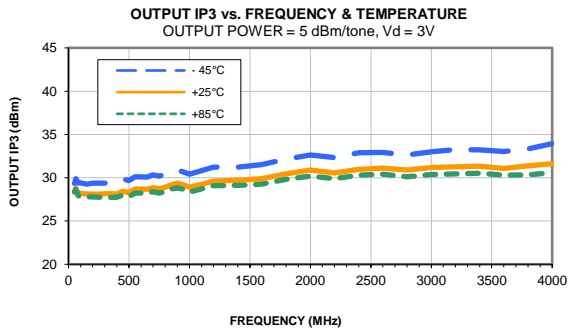

Outline Dimensions

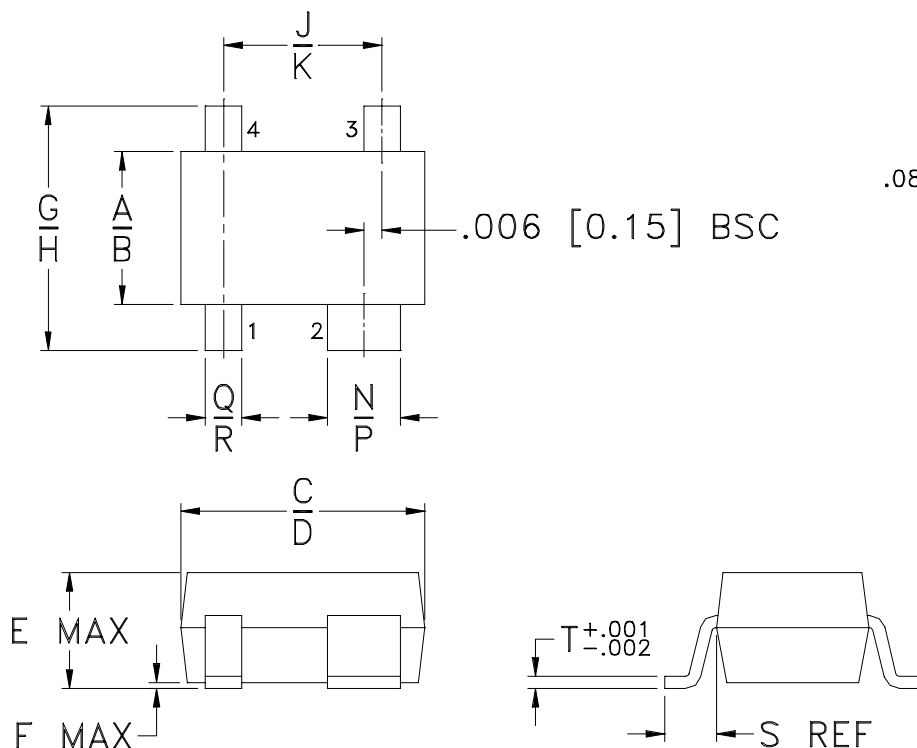

PCB Land Pattern

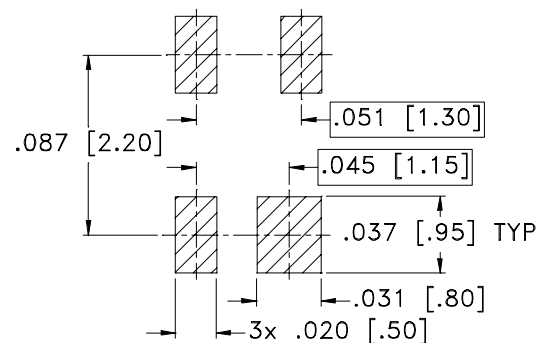

Suggested Layout,
Tolerance to be within $\pm .002$

CASE #.	A	B	C	D	E	F	G	H	J	K	L	M	N	P
MMM1362	.045 (1.15)	.053 (1.35)	.073 (1.85)	.089 (2.25)	.043 (1.10)	.004 (0.10)	.071 (1.80)	.094 (2.40)	.046 (1.17)	.056 (1.43)	-	-	.022 (0.55)	.028 (0.70)

CASE #.	Q	R	S	T	WT, GRAM
MMM1362	.010 (0.25)	.016 (0.40)	.017 (0.43)	.006 (0.15)	.007

Dimensions are in inches (mm). Tolerances: 2 Pl. $\pm .01$; 3 Pl. $\pm .005$

Notes:

- Case material: Plastic.
- Termination finish:
For RoHS Case Styles: Matte Tin plate.

Tape & Reel Packaging TR-F90

DEVICE ORIENTATION IN T&R

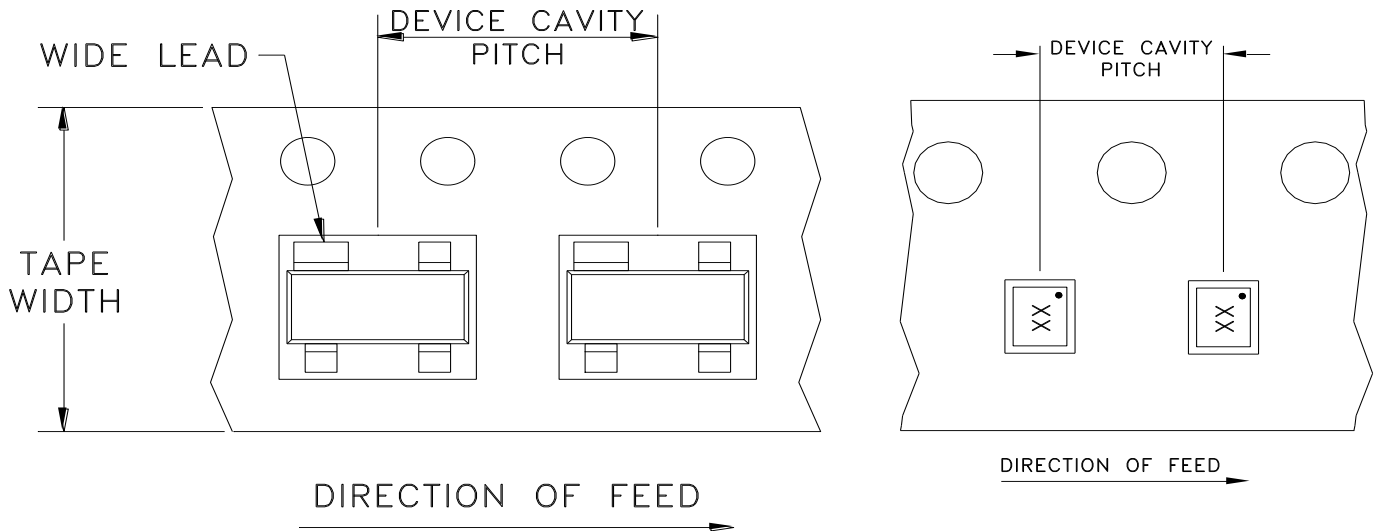

Applicable Case Style
MMM1362

NONE

Tape Width, mm	Device Cavity Pitch, mm	Reel Size, inches	Devices per Reel	
8	4	7	Small quantity standards (see note)	20
				50
				100
				200
				500
				1000
		7	Standards	2000
				3000

Note: Please Consult individual model data sheet to determine device per reel availability.

| [Applicable Case Styles](#) |

Mini-Circuits carrier tape materials provide protection from ESD (Electro-Static Discharge) during handling and transportation. Tapes are static dissipative and comply with industry standards EIA-481/EIA-541.

Go to: www.minicircuits.com/pages/pdfs/tape.pdf

| [MZ4532C](#) |

 **Mini-Circuits**[®]

INTERNET <http://www.minicircuits.com>

P.O. Box 350166, Brooklyn, New York 11235-0003 (718) 934-4500 Fax (718) 332-4661

Distribution Centers NORTH AMERICA 800-654-7949 • 417-335-5935 • Fax 417-335-5945 • EUROPE 44-1252-832600 • Fax 44-1252-837010

Mini-Circuits ISO 9001 & ISO 14001 Certified

THIRD ANGLE PROJECTION

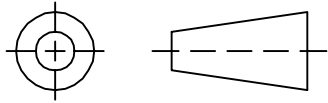

REVISIONS

REV OR	ECN No.	DESCRIPTION	DATE	DR	AUTH
	M135201	NEW RELEASE	12/29/11	AV	DJ

SUGGESTED MOUNTING CONFIGURATION FOR
MMM1362 CASE STYLE, "04AM04" PIN CODE

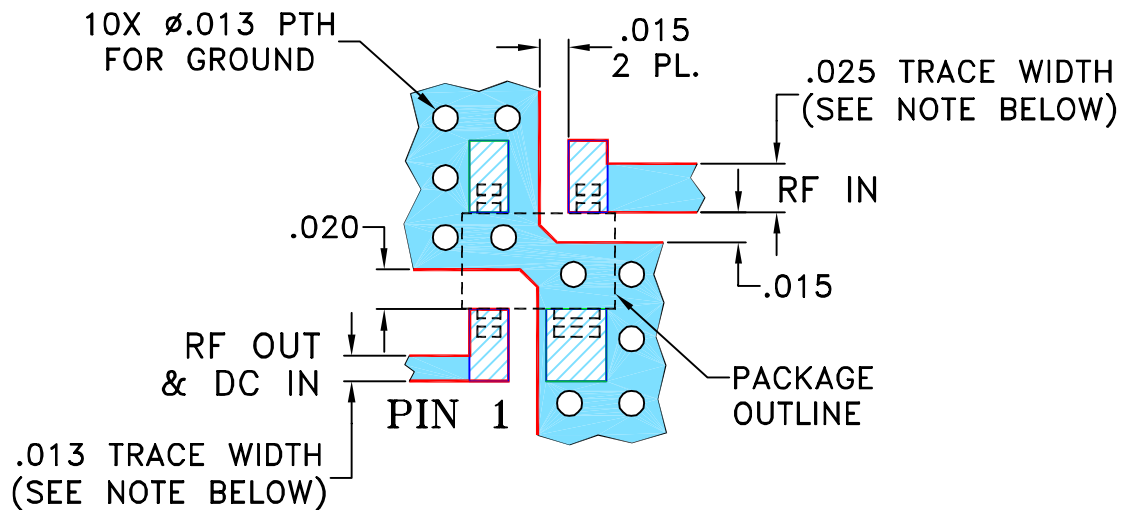

- NOTES: 1. TRACE WIDTH IS SHOWN FOR ROGERS R04350B WITH DIELECTRIC THICKNESS .010" ± .001"; COPPER: 1/2 OZ. EACH SIDE. FOR OTHER MATERIALS TRACE WIDTH MAY NEED TO BE MODIFIED.
2. BOTTOM SIDE OF THE PCB IS CONTINUOUS GROUND PLANE.



DENOTES PCB COPPER LAYOUT WITH SMOBC (SOLDER MASK OVER BARE COPPER)

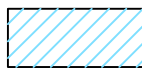

DENOTES COPPER LAND PATTERN FREE OF SOLDER MASK

UNLESS OTHERWISE SPECIFIED	INITIALS	DATE
DIMENSIONS ARE IN INCHES TOLERANCES ON: 2 PL DECIMALS ± 3 PL DECIMALS ± .005 ANGLES ± FRACTIONS ±	DRAWN	AV 12/23/11
	CHECKED	IL 12/29/11
	APPROVED	DJ 12/29/11



Mini-Circuits®

13 Neptune Avenue
Brooklyn NY 11235

PL, 04AM04, MMM1362, TB-653+

Mini-Circuits®
THIS DOCUMENT AND ITS CONTENTS ARE THE PROPERTY OF MINI-CIRCUITS. EXCEPT FOR USE EXPRESSLY GRANTED, IN WRITING, TO ITS VENDORS, VENDEE AND THE UNITED STATES GOVERNMENT, MINI-CIRCUITS RESERVES ALL PROPRIETARY DESIGN, USE, MANUFACTURING AND REPRODUCTION RIGHTS THERETO. THESE CONTENTS SHALL NOT BE USED, DUPLICATED OR DISCLOSED TO ANY OUTSIDE PARTY, IN WHOLE OR IN PART, WITHOUT WRITTEN PERMISSION OF MINI-CIRCUITS.

SIZE	CODE IDENT	DRAWING NO:	REV:
A	15542	98-PL-361	OR
FILE:	98PL361	SCALE: 10:1	SHEET: 1 OF 1

Evaluation Board and Circuit

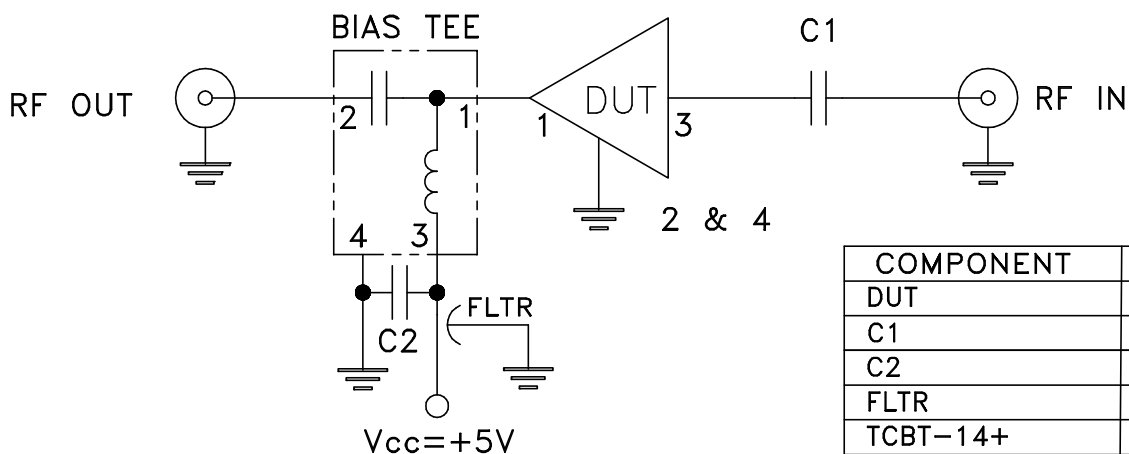
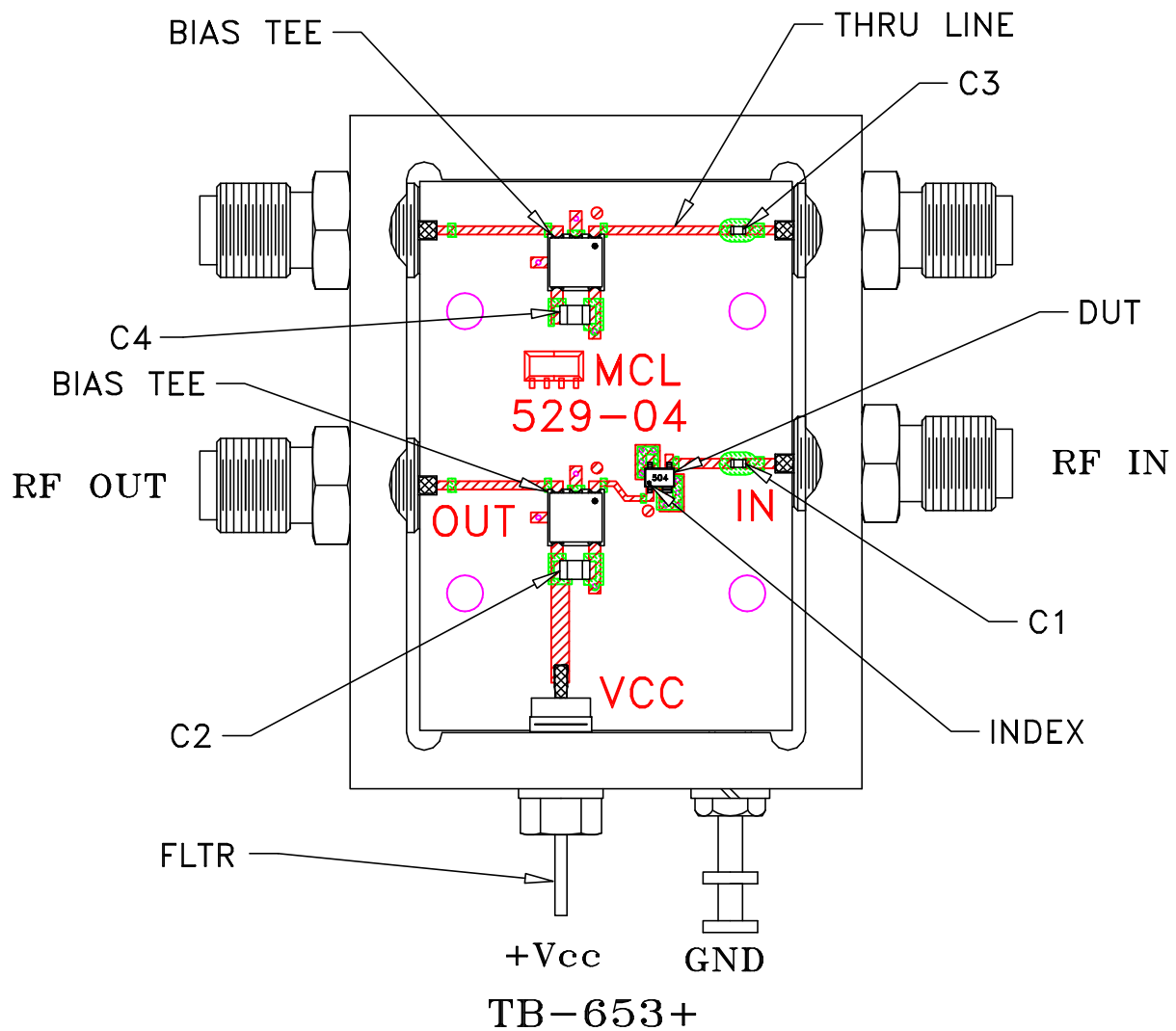

COMPONENT	VALUE
DUT	PSA4-5043+
C1	1000 pF
C2	0.1 uF
FLTR	1500 pF
TCBT-14+	MCL BIAS-TEE

Schematic Diagram

Notes:

1. 50 Ohm SMA Female connectors.
2. PCB Material: R04350 or equivalent, Dielectric Constant=3.5, Thickness=.010 inch.

 **Mini-Circuits®**

All Mini-Circuits products are manufactured under exacting quality assurance and control standards, and are capable of meeting published specifications after being subjected to any or all of the following physical and environmental test.

Specification	Test/Inspection Condition	Reference/Spec
Operating Temperature	-45° to 85°C or -40° to 85°C Ambient Environment	Individual Model Data Sheet
Storage Temperature	-65° to 150° C Ambient Environment	Individual Model Data Sheet
Thermal Shock	-55° to 100°C, 100 cycles	MIL-STD-202, Method 107, Condition A-3, except +100°C
Mechanical Shock	1.5Kg, 0.5 ms, 5 shock pulses, Y1 direction only	MIL-STD-883, Method 2002, Condition B, except Y1 direction only
Vibration (Variable Frequency)	50g peak	MIL-STD-883, Method 2007, Condition B
Autoclave	15 psig, 100% RH, 121°C, 96 hours	JESD22-A102, Condition C
HAST	130°C, 85% RH, 96 hours	JESD22-A110
Solderability	10X Magnification	J-STD-002, Para 4.2.5, Test S, 95% Coverage
Solder Reflow Heat	Sn-Pb Eutetic Process: 240°C peak Pb-Free Process: 260°C peak	J-STD-020, Table 4-1, 4-2 and 5-2; Figure 5-1
Moisture Sensitivity: Level 1	Bake at 125°C for 24 hours Soak at 85°C/85% RH for 168 hours, Reflow 3 cycles at 260°C peak	J-STD-020
Marking Resistance to Solvents	Isopropyl alcohol + mineral spirits at 25°C; terpene defluxer at 25°C; distilled water + proylene glycol monomethyl ether +	MIL-STD-202, Method 215



All Mini-Circuits products are manufactured under exacting quality assurance and control standards, and are capable of meeting published specifications after being subjected to any or all of the following physical and environmental test.

Specification	Test/Inspection Condition	Reference/Spec
	monoethanolamine at 63°C to 70°C	